

MC6 MkII User Manual (firmware 3.8)

Table of Contents

- 1 [Introduction](#)
- 2 [Power Requirements](#)
- 3 [Connections](#)
 - 3.1 [MIDI In](#)
 - 3.2 [MIDI Out](#)
 - 3.3 [USB](#)
 - 3.4 [9VDC](#)
 - 3.5 [EXP 1 and 2 - Omniports](#)
- 4 [Navigation](#)
 - 4.1 [Front Panel](#)
 - 4.2 [Banks and Presets](#)
- 5 [MIDI Message Types](#)
- 6 [Action Types](#)
- 7 [Programming Switches](#)
 - 7.1 [Using the Morningstar Device Editor](#)
 - 7.2 [Programming on the Controller Itself](#)
- 8 [Toggle Mode](#)
- 9 [Bank Settings](#)
- 10 [Bank Presets](#)
- 11 [Expression Pedals](#)
 - 11.1 [Connecting an Expression Pedal](#)
 - 11.2 [Programming an Expression Pedal Preset](#)
 - 11.3 [Select Expression Messages to Send or Omit](#)
- 12 [External Aux Switches](#)
- 13 [TRS MIDI Outputs - 1/4 Inch](#)
 - 13.1 [Switchable TRS MIDI Configuration](#)
- 14 [Copy, Paste and Swap Presets](#)
- 15 [Dual Switch Press Functions](#)
- 16 [Global Settings](#)
- 17 [Useful Concepts and Features](#)
- 18 [Update Firmware](#)
 - 18.1 [How to Update your Firmware](#)
 - 18.2 [Unsuccessful Firmware Update](#)
- 19 [Using an External MIDI Controller to control the MC6](#)
 - 19.1 [MIDI Implementation Charts](#)

Introduction

Welcome to your MC6 MIDI Controller. With this, you are able to control any device that accepts MIDI, regardless of brand or model. Each switch on your Morningstar controller can be programmed to perform any function you want.

We pride ourselves on making the easiest-to-use programmable MIDI controllers on the market. If you have any questions that this manual cannot answer, please send us an email at help@morningstarfx.com. We are happy to help.



If you wish to download a PDF copy of this manual, click on the file below.

Power Requirements

You can power your MC6 in any of the following ways.

9V DC (centre negative) Power Supply

Connect a 9VDC centre negative power supply to the power input of the MC6.

 The MC6 requires at least 120mA of power at 9VDC.

Phantom Power (9-12v AC or DC)

Connect a 7-pin MIDI cable to the MIDI Out port of the MC6. Phantom power can be supplied to the MC6 through pins 6 and 7 of the MIDI OUT port. When receiving DC power via phantom power, polarity does not matter. Phantom power that is received is chained to pins 6 & 7 of the MIDI IN port as well, allowing you to power other devices connected to it.

USB Power

Connect a USB cable from your computer, mobile device, USB adaptor or power bank to the MC6. The MC6 is capable of being powered fully by USB.

Connections



MIDI In

Where the MC6 receives MIDI messages from other MIDI devices.

The MC6 can receive MIDI messages via its MIDI in port and relay them out through its MIDI outputs (all MIDI message types) and USB port (only PC, CC, Note and MIDI Clock) .

MIDI Out

Where MIDI data is sent from the MC6 to other devices. Use a standard 5-pin MIDI cable. To phantom power your MC6, you can also use a 7-pin cable if you have a device that provides phantom power via pins 6 & 7.

USB

Send and receive MIDI via USB. This allows you to control your DAWs, plugins and other music software. All Morningstar controllers are USB class compliant and compatible with Windows, macOS, Android and iOS.

The MC6 can receive MIDI messages (only PC, CC, Note and MIDI Clock) via USB and relay them out through its 5-pin and 1/4 inch MIDI outputs.

9VDC

Where the MC6 receives 9v DC centre negative power.

EXP 1 and 2 - Omniports

Omniports are multi-function ports found on our MIDI controllers. Each port can be configured to work as any of the following:

- TRS MIDI Output (configurable to send via the tip or ring to suit all pedals) **or**
- TRS Expression Pedal Input **or**
- TRS Aux Switch Input (up to 3 switches per port)

You should only use **stereo cables**. Using Mono cables will cause the device not to work as intended.

Please note that these ports cannot be used to control functions like amp switching, sending analog tap tempo or for Control Voltage. You should only be connecting expression pedals, aux switches and MIDI devices to these ports.

 Applying power to the Omniports may damage your Morningstar controller.

Navigation

Front Panel

The MC6 has 6 foot switches A to F. Each switch corresponds with the text closest to it on the LCD display. Each switch on your Morningstar controller can send any combination of up to 16 different MIDI messages of your choice. By default all switches are EMPTY and not programmed to send any MIDI messages. It's up to you to decide what you want!

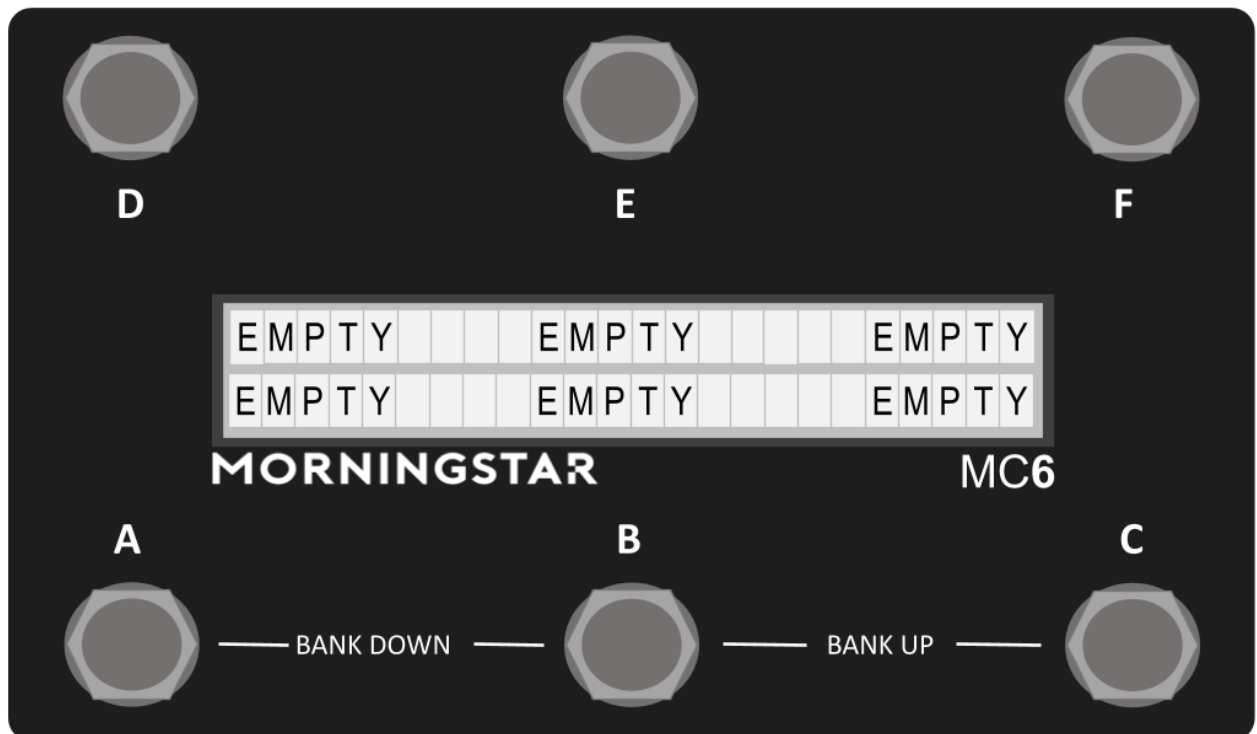

Preset Short Names – The “EMPTY” text you see are the default short names given to unused switches. You can give each switch any name you want, so you always know what it does before you press it.

The 2 middle rows on your main screen show important information:

Banks and Presets

The MC6 has 30 banks, each containing 12 switch presets and 2 expression pedal presets.

To bank up, press switches [B+C]. And to bank down, press [A+B]. Holding down either of these switch combinations will continuously scroll up/down through the banks.

Each bank has 2 pages. The first 6 switch presets (A to F) are accessible on page 1 and the next 6 (G to L) are accessible on page 2. You can toggle between both pages by assigning a Toggle Page function to any of the switches (we recommend using a Double Tap action for that so you can still use that switch for other purposes with a normal Press action).

Presets G to L in each bank are also accessible by connecting external aux switches to your MC6. You can learn more about this in the [Using External Aux Switches](#) section of this manual.

Each preset can be programmed to send 16 different messages of your choice. And with 16 different MIDI channels, each preset is capable of controlling up to 16 different MIDI devices at once.

The flow chart below shows you an overview of the MC6 bank and preset architecture.

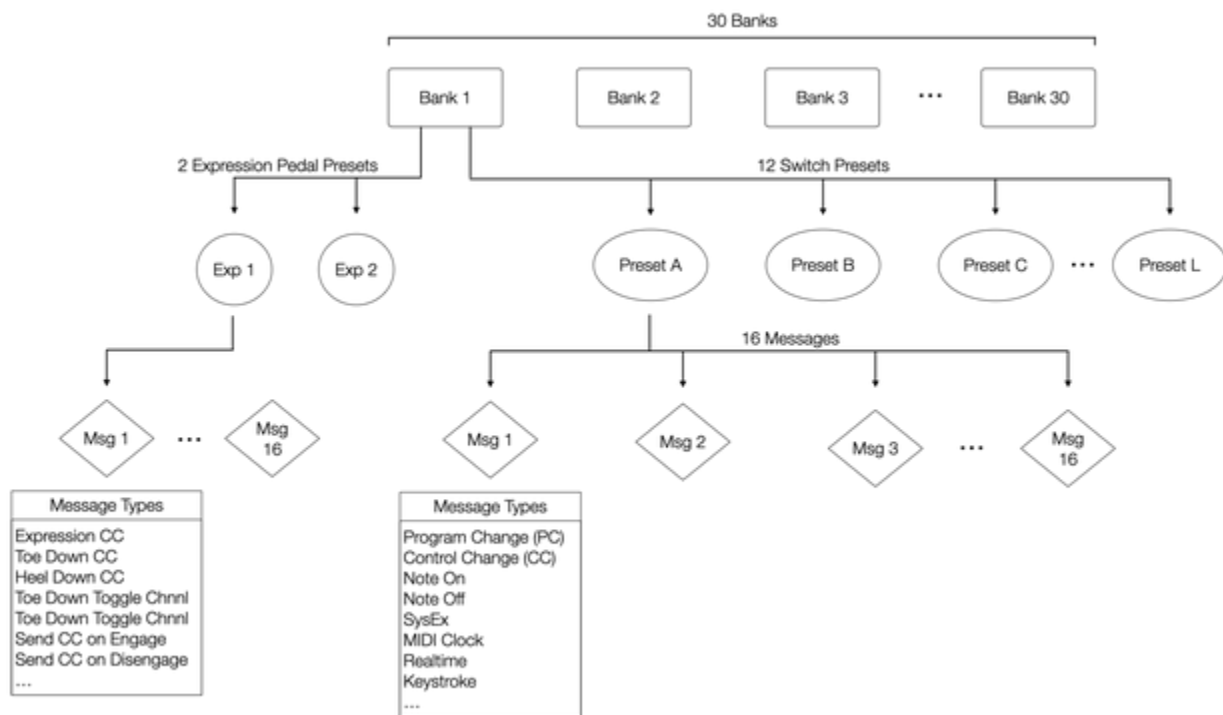

MIDI Message Types

Morningstar controllers can send virtually any type of MIDI messages you need.

From standard PC (Program Change) and CC (Control Change) messages to Note, SySex, Realtime, Keystroke commands and many more – your Morningstar controller has you covered.

For all the available MIDI message types and descriptions of what they do, please refer to our [MIDI Type Glossary](#). It gets continually updated as we add more features.

Action Types

You have the ability to send different MIDI messages by performing different actions on a switch. Such as Press, Double Tap, Release or Long Press (and more). This allows you to group MIDI messages by actions so a single switch can perform multiple functions.

For example, you can map a CC#1 message to a Press action, and a CC#2 message to a Release action. When the switch is pressed, a CC#1 message will be sent, and when the switch is released, a CC#2 messages will be sent.

For all the available Action types and their descriptions, please refer to the [Action Glossary](#).

Programming Switches

All switches on your Morningstar controller come empty by default. It's up to you to decide what you want each switch to do. Each switch can send up to 16 different MIDI messages simultaneously. The combination of MIDI messages a switch sends, makes up a preset.

There are 2 ways you can program your switches. By using the Morningstar Device Editor or programming on the controller itself.

Using the Morningstar Device Editor

 Watch <https://youtu.be/NEI0EievXd0> for a demo and tutorial on how to use the Device Editor.

The fastest and easiest way to program your switches is to use the Morningstar Device Editor. This will probably be your most commonly used method, as it gives you a clear visual representation of all your presets, banks and the MIDI messages being sent by each switch.







It also gives you access to many other features such as Preset & Bank Re-ordering, Controller Backup (backup your controller to your computer), MIDI CC Waveform Generators, MIDI Dictionary and much more.

We have a separate [MIDI Editor](#) manual for the Morningstar Device Editor. Please refer to that for more information.

 When testing your programmed switches, always make sure to exit Editor Mode by clicking on 'Disconnect Device' on the Editor. To ensure a smooth editing experience, some functions such as Bank Jump, Bank Up/Down and Toggle Page are disabled when your device is in Editor Mode.

Programming on the Controller Itself

Editing MIDI Messages

- 1. Select which switch to edit**
 - a. First, press the switch that you want to edit
 - b. Then press switches [D+F] to enter the editing menu. The switch you last pressed will be displayed in the menu. For eg. If your last pressed switch is switch A, you will see 'Preset A' in the menu
 - c. Press 'Preset A' to program switch A
- 2. Edit the messages being sent by this switch**
 - a. Press 'EditMsg' to edit the MIDI messages you want to send with this switch
- 3. Select which message you want to edit**
 - a. Use the  and  arrows to scroll through the 16 MIDI messages you can send. By default, all of them are empty until you select a message
 - b. Once you've scrolled to the message you want to edit, press 'Next'
- 4. Choose what action you want to use to send the message**
 - a. Use the  and  arrows to choose what action (Press, Release, Double Tap, Long Press etc) you want to use to send this MIDI message. For all the available Action types and their descriptions, please refer to the [Action Glossary](#)
 - b. Once you're done, press 'Next'
- 5. Choose which toggle position you want the message to be in**
 - a. You only need to be concerned with this setting if you want to use this switch as a toggle switch. If you are not not, leave toggle position at 'Both'.
 - b. If Toggle Mode is activated for a particular switch (refer to the [Toggle Mode](#) section for how to activate it), messages in Position 1 will be sent with the first press of a switch and messages in Position 2 will be sent upon the second press of a switch. Messages that get sent will alternate between positions 1 and 2 with each press. Messages set to 'Both' positions will get sent every time a switch is pressed, regardless of toggle position. If Toggle Mode is not activated, only messages in Position 1 or 'Both' will be sent.
 - c. Use the  and  arrows to choose which position you want this MIDI message to be in.

- d. Once you're done, press 'Next'.
6. **Choose what type of MIDI message you want**
 - a. Morningstar controllers can send virtually any type of MIDI messages you need. For all the available MIDI message types and descriptions of what they do, please refer to the [MIDI Type Glossary](#). It gets continually updated as we add more features.
 - b. Use the ▲ and ▼ arrows to choose what type of MIDI message you want to send.
 - c. Once you're done, press 'Next'
7. **Edit your message parameters**
 - a. Set the parameters for your chosen MIDI message type (eg. PC Number, CC Number, CC Value, Note Number, Note Velocity etc.)
 - b. Once you're done, press 'Next'
8. **Select the MIDI Channel you want to send the message on**
 - a. Use the ▲ and ▼ arrows to choose what MIDI channel you want to send this message on. It should be sent via the same channel that your receiving device is set to.
 - b. Once you're done, press 'Save'

Naming your Switches

While naming your switches on the controller itself is possible, we recommend using the Device Editor instead. If you wish to name your switches on the controller itself, do the following:

1. **Select which switch to edit**
 - a. First, press the switch that you want to edit
 - b. Then press switches [D+F] to enter the editing menu. The switch you last pressed will be displayed in the menu. For eg. If your last pressed switch is switch A, you will see 'Preset A' in the menu
 - c. Press 'Preset A' to program switch A
2. **Press 'NextPg' to scroll to the next page**
 - a. Press 'ShrtName' to edit your Switch's short name
 - b. Press 'FullName' to edit your Switch's long Name
 - c. Press 'ToggName' to edit your Switch's short name in toggle position 2
3. **Input your desired name**
 - a. Use the Left and Right switches to move through the name's characters
 - b. Use the Up and Down switches to scroll through characters and select your desired character
4. **Save the name**
 - a. Press switch E to save and exit
 - b. Press switch D to exit without saving

Toggle Mode

Toggle Mode allows each switch on your Morningstar MIDI controller to send different MIDI messages with each alternate press. This allows you to control your pedals and devices in useful and creative ways.

 Watch <https://youtu.be/VEr0TB58EgA> for a demo and tutorial on how to use Toggle Mode

Toggle Mode lets you separate your MIDI messages into 2 different groups – Position 1 and Position 2.

Messages in Position 1 will be sent the first time you press the switch, and messages in position 2 will be sent the second time you press the switch. With each press you will alternate between sending messages in Position 1 and Position 2.

Using the Device Editor

On the top left of the Device Editor interface, there is a button labelled Toggle Mode On/Off (just below the Short name field). Switch it on to enable Toggle Mode.

Each message on the Editor also has a Position setting – Pos 1, Pos 2 or Both.

When Pos 1 is selected, the message will only be sent when the preset is in toggle position 1. When Pos 2 is selected, the message will only be sent when the preset is in toggle position 2. When set to Both, the message will be sent regardless of which toggle position the preset is in.

In the example below, we have programmed Msg1 to be a PC message (PC#0) in Pos 1, and Msg2 to be a PC Message (PC#1) in Pos 2. With each alternate press, PC#0 and PC#1 will be sent.

Msg 1	Action	Press	Type	Program Change	Pos: 1	Clear	Copy	Paste
			PC Number	MIDI Channel				
			0	1				
Msg 2	Action	Press	Type	Program Change	Pos: 2	Clear	Copy	Paste
			PC Number	MIDI Channel				
			1	1				

 If you have not enabled Toggle Mode for a particular switch, leave toggle position at 'Both' for all MIDI messages.

Toggle Name

The Toggle Name is the switch name shown when a preset is in toggle position 2. With each alternate press, the Short Name and Toggle Name will be displayed.

Enabling Toggle Mode on the Controller Itself

Press [D+F] > Select Preset > Press [NextPg] till you see 'TglMode' > Press to enable/disable Toggle Mode

When editing individual messages, there will be an option to select the toggle position for the message you are editing. Choose Position 1, 2 or Both.

Name Blink

To show that a preset is in position 2, you can also make a switch name blink. If the Blink option is enabled, the Toggle Name will blink when the preset is in position 2.

Bank Settings

Pressing switches [D+F] will also allow you to edit the current bank's settings. For eg. if you are in Bank 1, just press 'Bank 1' to edit your Bank Settings.

In the Bank Settings Menu, you have the following options:

[BankName] - Bank Name

Name your bank.

[Copy] - Copy Bank

Copy the entire current bank

[Paste] - Paste Bank

Paste the last copied bank to the current bank. This will overwrite the current bank.

[Swap] - Swap Bank

Swap the current bank with the last copied bank.

[ClrTog] - Clear Toggles

When enabled, this feature will reset the toggle positions of all other presets within the bank to position 1. This is useful when you want only the last engaged preset to blink.

[BankPst] - Edit Bank Preset Messages

Edit your Bank Preset messages. Refer to the [Bank Presets](#) section for more information.

Bank Presets

  Watch https://youtu.be/q_X75WNI02c for a demo and tutorial on using Bank Presets

Bank Presets allow you to send up to 16 MIDI messages upon entering or exiting a particular bank. You can program your Bank Presets under the Edit Bank tab on the Morningstar Device Editor or on your controller itself.

If you select the 'On Enter' event for a particular MIDI message, it will be sent when you enter that particular bank. If you select 'On Exit', the MIDI message will be sent when you exit that particular bank.

Some useful applications would be for you to engage a preset the moment you enter a bank, or automatically put your controller into [Looper Mode](#) when you enter a bank for looper control.

Expression Pedals

 Watch <https://youtu.be/-TNTkqh-gEE> for a demo and tutorial on how to use an expression pedal with MIDI.

Connecting an Expression Pedal

Before using an expression pedal, check to make sure that the Exp port you are using is set to accept an expression pedal. You can access this menu by going to the Press [D+F] > Global Config Menu > ExprInpt > Press switch A or D until you see 'ExprnPdl' > Save and Exit.

The MC6 works only with TRS expression pedals. Expression pedals fitted with 10k ohm linear potentiometers give the most accurate and smoothest response, though 10k - 25k ohm linear potentiometers will work too. The potentiometer wiper should be connected to the Tip of the stereo cable, while the Ring and Sleeve should be connected to the outer lugs on the potentiometer.

Calibrating your Expression Pedal

When connecting a new Expression pedal, be sure to **calibrate** it first by going into the Edit menu (Press [D+F] > Select 'Exp 1 or 2' > Calibrate). Follow the instructions shown. First, put your expression pedal into heel down position. Ideally, the value 0 should be displayed. Press 'Next'. Then, put your expression pedal into toe down position. Ideally, the value 127 should be displayed. Press 'Save' to save your settings. Do not worry if you are unable get values of 0 and 127 for each position. Once calibration is complete, the MC6 will automatically optimize settings to suit your expression pedal.

Expression Pedal Sensitivity

Expression pedals not using 10k ohm potentiometers can cause jitters in the expression pedal readings. If you are experiencing this, you can lower the sensitivity of your expression pedal to eliminate the jitters. Press [D+F] > Exp 1 or 2 > Sens.

Expression Pedal Name

You can also name your expression preset so that its name is displayed up when you move the expression pedal. You can name your expression presets using the Device Editor or on the MC6 itself. Press [D+F] > Expr 1 or 2 > FullNme.

 The MC6 works with an expression pedal with a Linear potentiometer only. Log potentiometers will not work well.

Programming an Expression Pedal Preset

Programming using the Device Editor

First move the expression pedal that you want to use (it will show up on the Editor screen) or select it from the Preset dropdown list. You can then use the Editor to program the messages you want your expression pedal to send. Refer to this video for an in-depth tutorial: <https://youtu.be/-TNTkqh-gEE>

Programming on the Controller Itself

First move the expression pedal that you want to use, then press switches [D+F] to begin editing. The last moved expression pedal will be displayed on the menu.

For eg. If your last moved expression pedal is connected to Exp port 1, you will see 'Exp 1' in the menu. And if your last moved expression pedal is connected to Exp port 2, you will see 'Exp 2' in the menu.

Press [D+F] > Exp 1 or 2 > EditMsgs > Proceed to edit your expression messages

Select Expression Messages to Send or Omit

The [Select Expression Message](#) message type allows you to decide which expression messages you want to send or omit. You can use your MC6 foot switches to do this on the fly. Refer to this video for an in-depth tutorial: <https://youtu.be/m6rMVbxCoa4>

External Aux Switches

 Watch <https://youtu.be/IYEjzsaSbc> for a demo and tutorial on how to add aux switches to your controller.

Connect external aux switches for extra control. Under your Global Config settings, you can configure to behave as fully programmable switches or Fixed Switches to control banking up/down and page toggle.

Press [D+F] > GblConfg > ExprInput > Press switch A or D and choose either Aux Switch or Fixed Switch > Save and Exit.

Aux Switch - Your Aux switches will function as fully programmable switches, just like the built-in switches (sans the LCD display)

Fixed Switch - Your Aux switches will function as bank up, bank down and toggle page switches. Setting 1 and 2 swap the position of the bank up and bank down switches so you can have your preferred layout.

Using external aux switches will give you direct access to the presets (G to L) on the second page of each MC6 bank without having to toggle page.

The MC6 requires aux switches that are wired like in the schematic below. It has to be connected to the device with a stereo cable, where the Tip is connected to the ground via a SPST Footswitch, and similar to the Ring as well. Another switch can be added to connect both Tip and Ring to ground to engage an additional preset/setting. Please refer to the schematic below.

 There are a few pedal builders that sell such switches (we are not affiliated with these companies.):

Analog Endeavors

American Loopers

 The footswitches need to be Momentary and Normally Open

If you would like to build one yourself, you can refer to the following schematic:

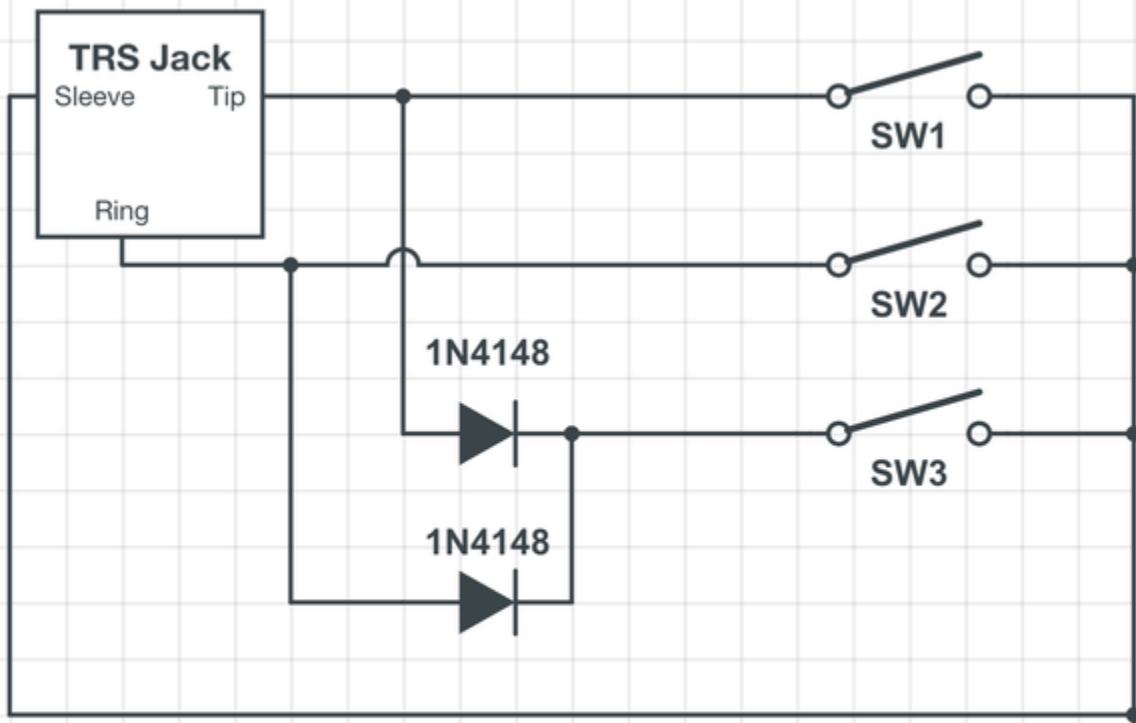



TRS MIDI Outputs - 1/4 Inch

Switchable TRS MIDI Configuration

Exp ports 1 and 2 (Omniports) on the MC6 can also be set to send MIDI via TRS. The TRS configuration can be adjusted via the menus on the device itself or by using the Device Editor.

i When connecting to some Chase Bliss devices such as the Mood, the MIDI Out - Ring Active setting will not work well as the Tip cannot be disconnected via software. Hence, using the MIDI Out setting and adjusting the jumpers to suit the Chase Bliss pedals will work best for these devices.

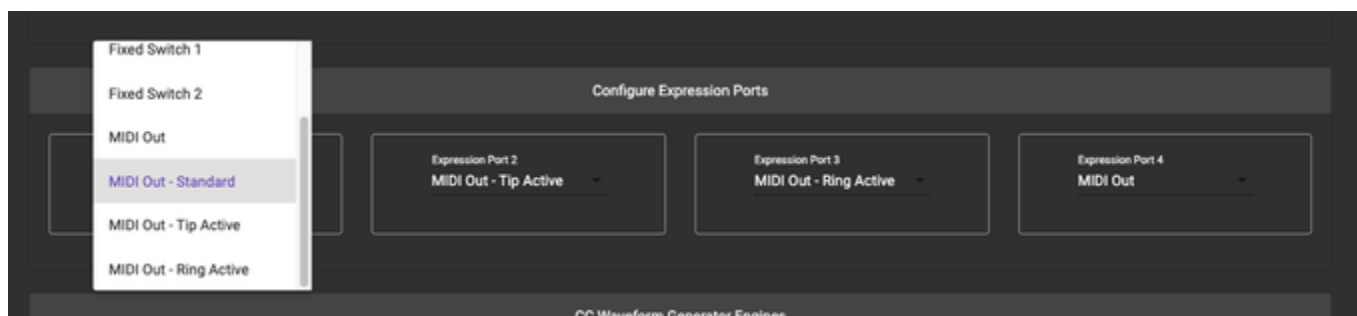

There are 3 TRS MIDI configurations available:

- MIDI Out - Standard : Send MIDI via the Tip and the Ring is powered
- MIDI Out - Tip Active : Send MIDI via the Tip and Ring is unpowered (floating)
- MIDI Out - Ring Active: Send MIDI via the Ring and Tip is unpowered (floating)

Copy, Paste and Swap Presets

You can copy, paste and swap presets on your MC6. These options are available on the device itself (press the switch you want to copy, press [D+F] > Preset > Copy, Paste, Swap) and on the Device Editor.

After you have copied your desired preset:

1. Press the switch you want overwrite or swap your copied preset with (it can be from any bank)
2. Press [D+F] > Preset > Paste, Swap

Paste - Will overwrite the current preset with your copied preset.

Swap - Will cause your copied preset and current preset to exchange positions.

Dual Switch Press Functions

Dual switch press combinations allow you to control certain **utility functions** and access **hidden presets** beyond the first 16 presets.

Utility Function	Switches
Bank Down	B+C

Bank Up	A+B
Enter Editing Menu	D+F
Toggle MIDI Thru On/Off	A+F

You can also use dual switch presses to trigger the presets on page 2 without having to toggle page.

Hidden Preset (on page 2 of each bank)	Switches
G	D+E
H	E+F
I	A+D
J	B+E
K	C+F

Global Settings

To access the Global Settings Menu, press switches [D+F] and then press Config. The following options will be displayed and you can use the **NextPage** button to scroll through more settings options.

[MidiChnl] - MIDI Channel

Set the MIDI receive channel for the MC6. The MC6 can receive and respond to MIDI messages from other MIDI controllers. Press Up or Down to select your desired MIDI receive channel.

[Reset] - Factory Reset

To perform a factory reset, hold down for 2 seconds. The display will show that it is performing a factory reset.



All user presets will be erased and all settings will be reset to factory default.

[Explnpt] - Exp 1 & 2 Ports (OmniPort) Settings

Set what each Omniport functions as – MIDI Output, Expression Pedal Input or Aux Switch Input. For more information, please refer to the [Omniports](#) section of this manual.

[SwSens] - Switch Sensitivity

Set switch sensitivity. Choose from 1 (least sensitive) to 5 (most sensitive). Pressing switches [B+C] will select level 3 sensitivity. Higher sensitivity means less delay between the time when a switch is pressed and when MIDI messages are sent out.



By default, sensitivity is set to level 3 and should be comfortable for most users. Depending on personal preference, you may adjust sensitivity to help you bank up/down (by stepping on 2 switches at once) more accurately.

Press Save to set the channel before exiting.

[BnkChgDI] - Bank Change Delay

Adjust the time it takes to load the next bank when the bank is changed. The unit of measurement is in milliseconds.

[DualLock] - Dual Switch Press Lock

When turned on, dual switch press functions like bank up/down and toggle page will be disabled.

[MidiClk] - Persistent MIDI Clock

Turn persistent MIDI clock ON or OFF. If persistent MIDI clock is ON, MIDI Clock data will continue to be sent even when you press another switch, change banks or move your expression pedal. If persistent MIDI clock is OFF, MIDI clock data will cease to be sent when an event (like a switch press or expression pedal move) is triggered.

[BnkTime] - Bank Display Time

Set the length of time your bank name and number will be displayed whenever you change banks. The unit of measurement is in milliseconds.

[MChnlNme] - MIDI Channel Names

Name each of your MIDI channels so you know which device each MIDI channel controls.

[MidiThru] - MIDI Thru

Enable or disable the passing through of MIDI messages received from the MIDI In port through the MIDI Out ports. All MIDI messages types are supported and will be passed through.

[LcdAlign] - Align Switch Names

When turned on, your switch's short name will be auto-aligned, depending on its position on the LCD. For example, switch A's name will be aligned to the left, while switch D's name will be aligned to the right.

[BankArng] - Bank Arrangement

Your banks can be re-arranged in this menu. More info [here](#).

[RstBkPst] - Reset Bank Presets

This resets all the Bank Presets to be empty.

[CrsMdTru] - Cross MIDI Thru

Enable or disable the passing through of MIDI messages received from the 5-pin MIDI input out through the USB port AND the passing through of MIDI messages received from the USB port out through all MIDI outputs.

 Not all MIDI message types are supported for Cross MIDI Thru. The supported MIDI message types are **PC, CC, Note, MIDI Clock, Pitch Change** and **After Touch**.

[RmbTog] - Remember Preset Toggle States Across Banks

Determine whether preset toggle states are remembered across banks even after you have changed banks. If ON, your presets will remain in their last used toggle state even as you scroll through banks. If OFF, your preset toggle states will reset once you exit a bank.

[LngPrsTm] - Long Press Time

Determine the amount of time (in milliseconds) you need to hold down a switch to trigger a Long Press action.

[IgnrClk] - Ignore Incoming MIDI Clock

If ON, incoming MIDI clock will be blocked and not passed through. If OFF, incoming MIDI clock received from either the USB port or MIDI IN port will be passed through to the MIDI outputs.

Useful Concepts and Features

There are many special functions and features on the controller to help you achieve your desired workflow. We have documented these concepts and features under [Concepts and Features](#)

- [Adding PC Scroll Numbers to your Preset Short / Toggle Name](#)
- [Looper Mode for Zero-latency Looper Control](#)
- [Preset Message Scroll \(scroll through messages within a preset\)](#)
- [Custom Bank Sequence](#)
- [CC Waveform Generators](#)
- [CC Sequencer Generators](#)
- [Toggle Switch Mode \(send different MIDI messages with each alternate press\)](#)
- [Sending incremental/decremental PC numbers or CC Values](#)
- [Using Strymon Nixie with Morningstar Controllers](#)
- [Using a Bluetooth MIDI adaptor to connect with the Editor \(CME WIDI\)](#)
- [Using the Web Editor on a Mobile Device](#)
- [Bank Presets \(send MIDI messages upon entering or exiting a bank\)](#)

Update Firmware

We regularly update our controllers' firmware to introduce new features, improve performance and fix bugs.

  Watch video tutorial <https://youtu.be/wtvX8Y9LzXo>

How to Update your Firmware

1. To update your Morningstar controller firmware, you first need to download the **Morningstar Firmware Updater** from the [Morningstar website](#) in the 'Downloads' section. Both Mac OS and Windows versions are available. Just download the correct version for your operating system. Download the Firmware Uploader [here](#).
-



2. Install the Firmware Updater on your computer. If you are on Mac OS, you may need to go into your security and privacy settings and click on Open Anyway to allow the application to be installed.
3. After you've installed the Firmware Updater, you'll need to **download the latest firmware**, also found under the 'Downloads' section on the Morningstar Website. Download the latest MC6 firmware [here](#)
4. Once you've downloaded it, **launch the Morningstar Firmware Updater and connect your MIDI controller to your computer via USB**. Your controller will automatically be recognised by the Updater.
5. Click on the Upload button and open the new firmware .hex file from your downloads folder. The firmware update will begin automatically and your controller will restart. That's it!

Unsuccessful Firmware Update

In the rare event where your device upload is not successful, the device might appear to be bricked with blocks showing across the LCD screen. Do not worry and follow these steps:

1. Download the latest firmware from our website.
2. Remove the back cover for your device and locate the reset button.
3. While the device is connected to your computer via USB, and with the Firmware Uploader open, press the reset button location on the PCB.
4. Once pressed, the Firmware Uploader should detect the device. Thereafter, repeat the above upload procedure.

Using an External MIDI Controller to control the MC6

The MC6 can be controlled by external MIDI controllers, via both its MIDI input and USB port.

MIDI Implementation Charts

PC Messages

PC messages will change the banks on the MC6, where a PC#0 message will engage Bank 1, and PC#1 message will engage Bank 2, and so on.

MIDI PC Implementation Chart

PC#	Bank
0	1
1	2
2	3

.	.
.	.
.	.
29	30

CC Messages

CC messages allow you to navigate through the MC6's banks, engage presets and clear toggle states.

MIDI CC Implementation Chart

Function	CC#	Value
Bank Up	0	any
Bank Down	1	any
Set Toggle (All)	2	127
Set Toggle (Individual)	2	0 = Preset A 1 = Preset B 2 = Preset C . . . 11 = Preset L
Clear Toggle (All)	3	127
Clear Toggle (Individual)	3	0 = Preset A 1 = Preset B 2 = Preset C . . . 11 = Preset L
Toggle Page	4	any
Engage Preset	10 = Preset A 11 = Preset B 12 = Preset C . . . 11 = Preset L	0 = Do Nothing 1 = Press 2 = Release 3 = Long Press 4 = Long Press Release 5 = Double Tap 6 = Double Tap Release 7 = Double Tap Hold 8 = Double Tap Hold Release 9 = Release All 10 = Long Press Scroll
Set MIDI BPM (MSB 2 bits)	5	0-127
Set MIDI BPM (LSB 7 bits)	6	0-127
Engage Expression 1	51	0-127
Engage Expression 2	52	0-127