

# [In Progress] Revised MC8 Manual - Firmware v3.8

## Table of Contents

- 1 [Introduction](#)
- 2 [Power Requirements](#)
- 3 [Connections](#)
  - 3.1 [Omniports 1 to 4](#)
  - 3.2 [9VDC](#)
  - 3.3 [USB](#)
  - 3.4 [MIDI In](#)
  - 3.5 [MIDI Out](#)
- 4 [Navigation](#)
  - 4.1 [Front Panel](#)
  - 4.2 [Banks and Presets](#)
- 5 [MIDI Message Types](#)
- 6 [Action Types](#)
- 7 [Programming Switches](#)
  - 7.1 [Using Morningstar Device Editor](#)
  - 7.2 [Programming on the Controller Itself](#)
- 8 [Toggle Mode](#)
- 9 [Bank Settings](#)
- 10 [Bank Presets](#)
- 11 [Expression Pedals](#)
  - 11.1 [Connecting an Expression Pedal](#)
  - 11.2 [Programming an Expression Pedal Preset](#)
  - 11.3 [Select Expression Messages to Send or Omit](#)
- 12 [External Aux Switches](#)
- 13 [TRS MIDI Outputs \(1/4 Inch\)](#)
  - 13.1 [Switchable TRS MIDI Configuration](#)
- 14 [Copy, Paste and Swap Presets](#)
- 15 [Dual Switch Press Functions](#)
- 16 [Global Settings](#)
- 17 [Useful Concepts and Features](#)
- 18 [Update Firmware](#)
  - 18.1 [How to Update your Firmware](#)
  - 18.2 [Unsuccessful Firmware Update](#)
- 19 [Using an External MIDI Controller to control the MC8](#)
  - 19.1 [MIDI Implementation Charts](#)

---

## Introduction

Welcome to your MC8 MIDI Controller. With this, you are able to control any device that accepts MIDI, regardless of brand or model. Each switch on your Morningstar controller can be programmed to perform any function you want.

We pride ourselves on making the easiest-to-use programmable MIDI controllers on the market. If you have any questions that this manual cannot answer, please send us an email at [help@morningstarfx.com](mailto:help@morningstarfx.com). We are happy to help.

 If you wish to download a PDF copy of this manual, click on the file below.



MC8 User Manua...021-06-03).pdf

---

## Power Requirements

You can power your MC8 in any of the following ways.

### 9V DC (centre negative) Power Supply

Connect a 9VDC centre negative power supply to the power input of the MC8.

 The MC8 requires at least 250mA of power at 9VDC.

### Phantom Power (9-12v AC or DC)

Connect a 7-pin MIDI cable to the MIDI Out port of the MC8. Phantom power can be supplied to the MC8 through pins 6 and 7 of the MIDI OUT port. When receiving DC power via phantom power, polarity does not matter. Phantom power that is received is chained to pins 6 & 7 of the MIDI IN port as well, allowing you to power other devices connected to it.

### USB Power

Connect a USB cable from your computer, mobile device, USB adaptor or power bank to the MC8. The MC8 is capable of being powered fully by USB.

---

## Connections



## Omniports 1 to 4

Omniports are multi-function ports found on our MIDI controllers. Each port can be configured to work as any of the following:

- TRS MIDI Output (configurable to send via the tip or ring to suit all pedals) **or**
- TRS Expression Pedal Input **or**
- TRS Aux Switch Input (up to 3 switches per port)

You should only use **stereo cables**. Using Mono cables will cause the device not to work as intended.

Please note that these ports cannot be used to control functions like amp switching, sending analog tap tempo or for Control Voltage. You should only be connecting expression pedals, aux switches and MIDI devices to these ports.

 Applying power to the Omniports may damage your Morningstar controller.

## 9VDC

Where the MC8 receives 9v DC centre negative power.

## USB

Send and receive MIDI via USB. This allows you to control your DAWs, plugins and other music software. All Morningstar controllers are USB class compliant and compatible with Windows, macOS, Android and iOS.

The MC8 can receive MIDI messages (only PC, CC, Note and MIDI Clock) via USB and relay them out through its 5-pin and 1/4 inch MIDI outputs.

## MIDI In

Where the MC8 receives MIDI messages from other MIDI devices.

The MC8 can receive MIDI messages via its MIDI in port and relay them out through its MIDI outputs (all MIDI message types) and USB port (only PC, CC, Note and MIDI Clock) .

## MIDI Out

Where MIDI data is sent from the MC8 to other devices. Use a standard 5-pin MIDI cable. To phantom power your MC8, you can also use a 7-pin cable if you have a device that provides phantom power via pins 6 & 7.

## Navigation

## Front Panel

The MC8 has 8 foot switches A to H. Each switch corresponds with the text closest to it on the LCD display. Each switch on your Morningstar controller can send any combination of up to 16 different MIDI messages of your choice. By default all switches are EMPTY and not programmed to send any MIDI messages. It's up to you to decide what you want!

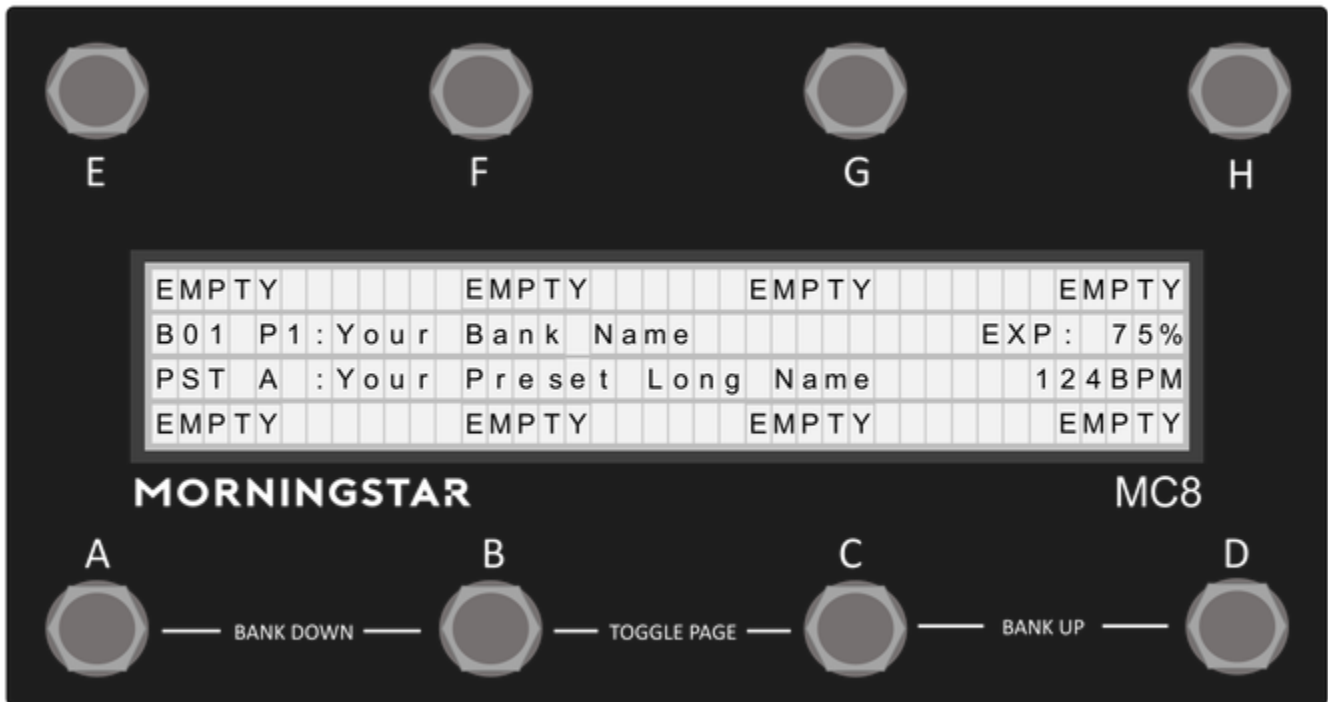

**Preset Short Names** – The “EMPTY” text you see are the default short names given to unused switches. You can give each switch any name you want, so you always know what it does before you press it.

The 2 middle rows on your main screen show important information:

**Bank and Page Number** – In the image above, “B01 P1” indicates that you are in Bank 1 and Page 1 of this bank (each of the 30 banks in your controller has 2 pages).

**Bank Name** – You can name each bank and its name will show up here, so you know what bank you are in.

**Currently Activated Preset (the last pressed switch)** – In the image above, “PST A” shows that the last pressed switch was switch A.

**Preset Long Name** – In addition to its short name, you can also give each preset a long name, which will show up here, so you know which preset is currently activated.

**Expression Pedal Position** – You can connect an expression pedal to your Morningstar controller for smooth continuous MIDI control. Its position (0 to 100%) will be shown on the screen.

**MIDI Clock BPM** – All Morningstar controllers can send MIDI clock to sync your time-based effects. The BPM of the MIDI clock being sent will be displayed here on the screen, and blink in time with the BPM.

## Banks and Presets

The MC8 has 30 banks, each containing 22 switch presets and 4 expression pedal presets.

To bank up, press switches [C+D]. And to bank down, press [A+B]. Holding down either of these switch combinations will continuously scroll up/down through the banks.

Each bank has 2 pages. The first 8 switch presets (A to H) are accessible on page 1 and the next 8 (I to P) are accessible on page 2. You can toggle between both pages by pressing switches [B+C].

The final 6 presets in each bank (Q to V) are accessible by connecting external aux switches to your MC8. You can learn more about this in the [Using External Aux Switches](#) section of this manual.

Each preset can be programmed to send 16 different messages of your choice. And with 16 different MIDI channels, each preset is capable of controlling up to 16 different MIDI devices at once.

The flow chart below shows you an overview of the MC8 bank and preset architecture.

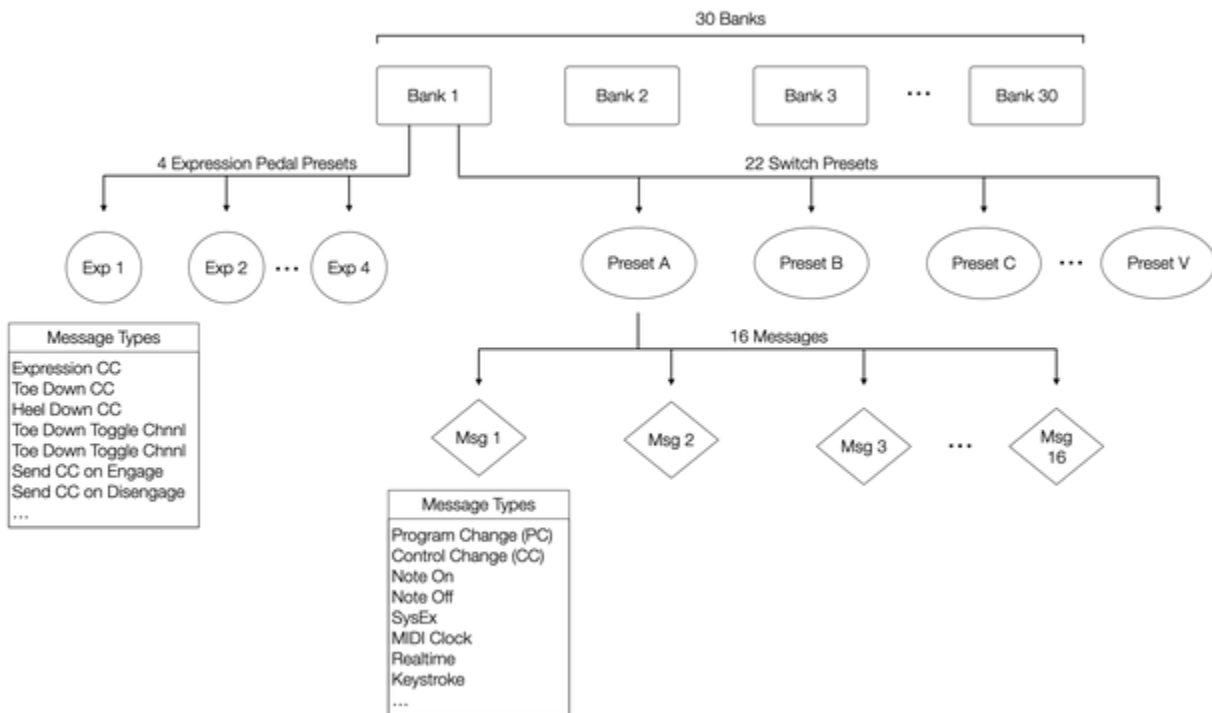

---

## MIDI Message Types

Morningstar controllers can send virtually any type of MIDI messages you need.

From standard PC (Program Change) and CC (Control Change) messages to Note, SySex, Realtime, Keystroke commands and many more – your Morningstar controller has you covered.

For all the available MIDI message types and descriptions of what they do, please refer to our [MIDI Type Glossary](#). It gets continually updated as we add more features.

---

## Action Types

You have the ability to send different MIDI messages by performing different actions on a switch. Such as Press, Double Tap, Release or Long Press (and more). This allows you to group MIDI messages by actions so a single switch can perform multiple functions.

For example, you can map a CC#1 message to a Press action, and a CC#2 message to a Release action. When the switch is pressed, a CC#1 message will be sent, and when the switch is released, a CC#2 messages will be sent.

For all the available Action types and their descriptions, please refer to the [Action Glossary](#).

---

# Programming Switches

All switches on your Morningstar controller come empty by default. It's up to you to decide what you want each switch to do. Each switch can send up to 16 different MIDI messages simultaneously. The combination of MIDI messages a switch sends, makes up a preset.

There are 2 ways you can program your switches. By using the Morningstar Device Editor or programming on the controller itself.

## Using Morningstar Device Editor

 Watch <https://youtu.be/NEI0EievXd0> for a demo and tutorial on how to use the Device Editor.

The fastest and easiest way to program your switches is to use the Morningstar Device Editor. This will probably be your most commonly used method, as it gives you a clear visual representation of all your presets, banks and the MIDI messages being sent by each switch.









It also gives you access to many other features such as Preset & Bank Re-ordering, Controller Backup (backup your controller to your computer), MIDI CC Waveform Generators, MIDI Dictionary and much more.

We have a separate [MIDI Editor](#) manual for the Morningstar Device Editor. Please refer to that for more information.

 When testing your programmed switches, always make sure to exit Editor Mode by clicking on 'Disconnect Device' on the Editor. To ensure a smooth editing experience, some functions such as Bank Jump, Bank Up/Down and Toggle Page are disabled when your device is in Editor Mode.

## Programming on the Controller Itself

### Editing MIDI Messages

- 1. Select which switch to edit**
  - a. First, press the switch that you want to edit
  - b. Then press switches [E+H] to enter the editing menu. The switch you last pressed will be displayed in the menu. For eg. If your last pressed switch is switch A, you will see 'Preset A' in the menu
  - c. Press 'Preset A' to program switch A
- 2. Edit the messages being sent by this switch**
  - a. Press 'EditMsgs' to edit the MIDI messages you want to send with this switch
- 3. Select which message you want to edit**
  - a. Use the  and  arrows to scroll through the 16 MIDI messages you can send. By default, all of them are empty until you select a message
  - b. Once you've scrolled to the message you want to edit, press 'Next'
- 4. Choose what action you want to use to send the message**
  - a. Use the  and  arrows to choose what action (Press, Release, Double Tap, Long Press etc) you want to use to send this MIDI message. For all the available Action types and their descriptions, please refer to the [Action Glossary](#)
  - b. Once you're done, press 'Next'
- 5. Choose which toggle position you want the message to be in**
  - a. If Toggle Mode is activated for a particular switch (refer to the [Toggle Mode](#) section for how to activate it), messages in Position 1 will be sent with the first press of a switch and messages in Position 2 will be sent upon the second press of a switch. Messages that get sent will alternate between positions 1 and 2 with each press. Messages set to 'Both' positions will get sent every time a switch is pressed, regardless of toggle position. If Toggle Mode is not activated, only messages in Position 1 or 'Both' will be sent.
  - b. Use the  and  arrows to choose which position you want this MIDI message to be in.
  - c. Once you're done, press 'Next'.
- 6. Choose what type of MIDI message you want**
  - a. Morningstar controllers can send virtually any type of MIDI messages you need. For all the available MIDI message types and descriptions of what they do, please refer to the [MIDI Type Glossary](#). It gets continually updated as we add more features.
  - b. Use the  and  arrows to choose what type of MIDI message you want to send.
  - c. Once you're done, press 'Next'
- 7. Edit your message parameters**
  - a. Set the parameters for your chosen MIDI message type (eg. PC Number, CC Number, CC Value, Note Number, Note Velocity etc.)
  - b. Once you're done, press 'Next'
- 8. Select the MIDI Channel you want to send the message on**

- a. Use the ▲ and ▼ arrows to choose what MIDI channel you want to send this message on. It should be sent via the same channel that your receiving device is set to.
- b. Once you're done, press 'Save'

## Naming your Switches

While naming your switches on the controller itself is possible, we recommend using the Device Editor instead. If you wish to name your switches on the controller itself, do the following:

1. **Select which switch to edit**
  - a. First, press the switch that you want to edit
  - b. Then press switches [E+H] to enter the editing menu. The switch you last pressed will be displayed in the menu. For eg. If your last pressed switch is switch A, you will see 'Preset A' in the menu
  - c. Press 'Preset A' to program switch A
2. **Press the 'Pg 1/3' switch to scroll to the next page**
  - a. Press 'ShrtName' to edit your Switch's short name
  - b. Press 'FullName' to edit your Switch's long Name
  - c. Press 'TgleName' to edit your Switch's short name in toggle position 2
3. **Input your desired name**
  - a. Use the Left and Right switches to scroll move through the name
  - b. Use the Up and Down switches to scroll through characters
4. **Save the name**
  - a. Press 'Save' to save the name
  - b. Press 'Exit'

## Toggle Mode

Toggle Mode allows each switch on your Morningstar MIDI controller to send different MIDI messages with each alternate press. This allows you to control your pedals and devices in useful and creative ways.

 Watch <https://youtu.be/VEr0TB58EgA> for a demo and tutorial on how to use Toggle Mode

Toggle Mode lets you separate your MIDI messages into 2 different groups – Position 1 and Position 2.

Messages in Position 1 will be sent the first time you press the switch, and messages in position 2 will be sent the second time you press the switch. With each press you will alternate between sending messages in Position 1 and Position 2.

### Using the Device Editor

On the top left of the Device Editor interface, there is a button labelled Toggle Mode On/Off (just below the Short name field). Switch it on to enable Toggle Mode.

Each message on the Editor also has a Position setting – Pos 1, Pos 2 or Both.

When Pos 1 is selected, the message will only be sent when the preset is in toggle position 1. When Pos 2 is selected, the message will only be sent when the preset is in toggle position 2. When set to Both, the message will be sent regardless of which toggle position the preset is in.

In the example below, we have programmed Msg1 to be a PC message (PC#0) in Pos 1, and Msg2 to be a PC Message (PC#1) in Pos 2. With each alternate press, PC#0 and PC#1 will be sent.

Msg 1	Action	Press	Type	Program Change	Pos: 1	Clear	Copy	Paste
			PC Number	MIDI Channel				
			0	1				
Msg 2	Action	Press	Type	Program Change	Pos: 2	Clear	Copy	Paste
			PC Number	MIDI Channel				
			1	1				

### Toggle Name

The Toggle Name is the switch name shown when a preset is in toggle position 2. With each alternate press, the Short Name and Toggle Name will be displayed.

### Enabling Toggle Mode on the Controller Itself

Press [E+H] > Select Preset > Scroll to Pg 3 > Select TgleMode On/Off

When editing individual messages, there will be an option to select the toggle position for the message you are editing. Choose Position 1, 2 or Both.

### Name Blink

To show that a preset is in position 2, you can also make a switch name blink. If the Blink option is enabled, the Toggle Name will blink when the preset is in position 2.

---

## Bank Settings

Pressing switches [E+H] will also allow you to edit the current bank's settings. For eg. if you are in Bank 1, just press 'Bank 1' in the top right corner to edit your Bank Settings.

In the Bank Settings Menu, you have the following options:

### [BankName] - Bank Name

Name your bank.

### [Copy] - Copy Bank

Copy the entire current bank

### [Paste] - Paste Bank

Paste the last copied bank to the current bank. This will overwrite the current bank.

### [ClearTgs] - Clear Toggles

When enabled, this feature will reset the toggle positions of all other presets within the bank to position 1. This is useful when you want only the last engaged preset to blink.

### [EditMsgs] - Edit Messages

Edit your Bank Preset messages. Refer to the [Bank Presets](#) section for more information.

---

## Bank Presets

Bank Presets allow you to send up to 16 MIDI messages upon entering or exiting a particular bank. You can program your Bank Presets under the Edit Bank tab on the Morningstar Device Editor or on your controller itself.

If you select the 'On Enter' event for a particular MIDI message, it will be sent when you enter that particular bank. If you select 'On Exit', the MIDI message will be sent when you exit that particular bank.

Some useful applications would be for you to engage a preset the moment you enter a bank, or automatically put your controller into [Looper Mode](#) when you enter a bank for looper control.

---

## Expression Pedals



Watch <https://youtu.be/-TNTkqh-gEE> for a demo and tutorial on how to use an expression pedal with MIDI.

### Connecting an Expression Pedal

Before using an expression pedal, check to make sure that the Omniport you are using is set to accept an expression pedal. You can access this menu by going to the Press [E+H] > Global Config Menu > OmniPort > Scroll until you see ExprnPedal > Save and Exit.

The MC8 works only with TRS expression pedals. Expression pedals fitted with 10k ohm linear potentiometers give the most accurate and smoothest response, though 10k - 25k ohm linear potentiometers will work too. The potentiometer wiper should be connected to the Tip of the stereo cable, while the Ring and Sleeve should be connected to the outer lugs on the potentiometer.



## Calibrating your Expression Pedal

When connecting a new Expression pedal, be sure to **calibrate** it first by going into the Edit menu (Press [E+H] > Select Expr X > Calibrate). Follow the instructions shown. First, put your expression pedal into heel down position. Ideally, the value 0 should be displayed. Press 'Next'. Then, put your expression pedal into toe down position. Ideally, the value 127 should be displayed. Press 'Save' to save your settings. Do not worry if you are unable get values of 0 and 127 for each position. Once calibration is complete, the MC8 will automatically optimize settings to suit your expression pedal.

## Expression Pedal Sensitivity

Expression pedals not using 10k ohm potentiometers can cause jitters in the expression pedal readings. If you are experiencing this, you can lower the sensitivity of your expression pedal to eliminate the jitters. Press [E+H] > Expr X > Sens.

## Expression Pedal Name

You can also name your expression preset so that its name is displayed up when you move the expression pedal. You can name your expression presets using the Device Editor or on the MC8 itself. Press [E+H] > Expr X > FullName.

 The MC8 works with an expression pedal with a Linear potentiometer only. Log potentiometers will not work well.

## Programming an Expression Pedal Preset

### Programming using the Device Editor

First move the expression pedal that you want to use (it will show up on the Editor screen) or select it from the Preset dropdown list. You can then use the Editor to program the messages you want your expression pedal to send. Refer to this video for an in-depth tutorial: <https://youtu.be/TNTkqh-gEE>

### Programming on the Controller Itself

First move the expression pedal that you want to use, then press switches [E+H] to begin editing. The last moved expression pedal will be displayed on the menu. For eg. If your last moved expression pedal is connected to Omniport 1, you will see 'Expr 1' in the menu.



And if your last moved expression pedal is connected to Omniport 2, you will see 'Expr 2' in the menu.

Press [E+H] > Expr X > EditMsgs > Proceed to edit your expression messages

## Select Expression Messages to Send or Omit

The [Select Expression Message](#) message type allows you to decide which expression messages you want to send or omit. You can use your MC8 foot switches to do this on the fly. Refer to this video for an in-depth tutorial: <https://youtu.be/m6rMVbxCoa4>

## External Aux Switches

  Watch <https://youtu.be/1YEjrzaSbc> for a demo and tutorial on how to add aux switches to your controller.

Connect external aux switches for extra control. You can configure in your Omniport settings, to behave as fully programmable switches or fixed switches to control banking up/down and page toggle.

You can control the following extra MC8 presets when connected to each of the following Omniports:

- Omniport 1: Presets Q, R, S
- Omniport 2: Presets T, U, V
- Omniport 3: Presets I, J, K
- Omniport 4: Presets L, M, N

The MC8 requires aux switches that are wired like in the schematic below. It has to be connected to the device with a stereo cable, where the Tip is connected to the ground via a SPST Footswitch, and similar to the Ring as well. Another switch can be added to connect both Tip and Ring to ground to engage an additional preset/setting. Please refer to the schematic below.

There are a few pedal builders that sell such switches (we are not affiliated with these companies.):

Analog Endeavors

American Loopers

The footswitches need to be Momentary and Normally Open

If you would like to build one yourself, you can refer to the following schematic:

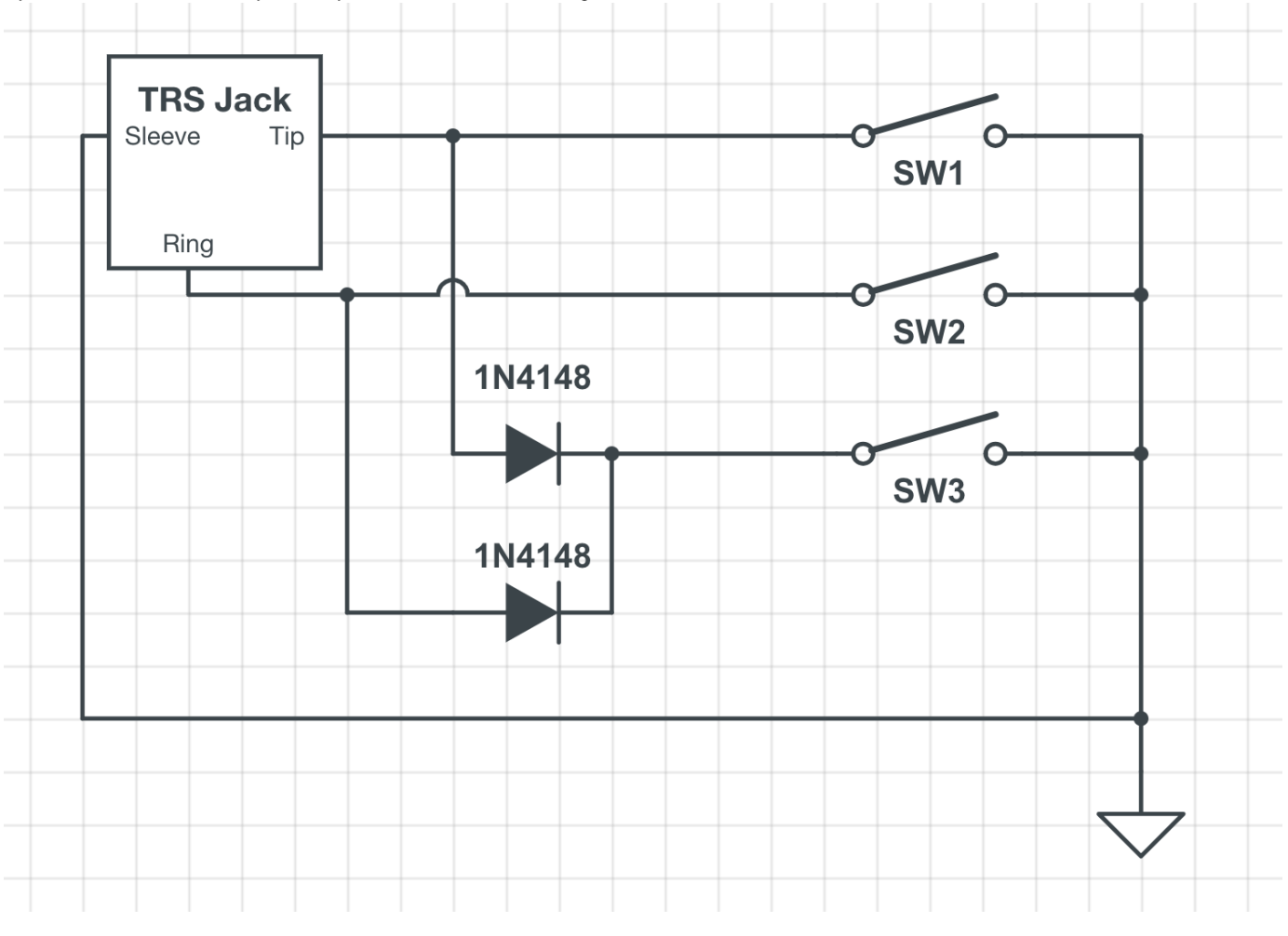

## TRS MIDI Outputs (1/4 Inch)

### Switchable TRS MIDI Configuration

With Firmware v3.8 onwards, you no longer need to move the jumper switches in the MC8 to change your Omniport TRS MIDI configurations. The TRS settings can be adjusted via the menus on the device itself or by using the Device Editor.

When connecting to some Chase Bliss devices such as the Mood, the MIDI Out - Ring Active setting will not work well as the Tip cannot be disconnected via software. Hence, using the MIDI Out setting and adjusting the jumpers to suit the Chase Bliss pedals will work best for these devices.

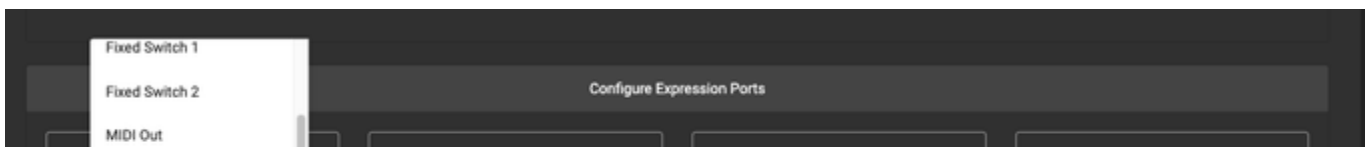

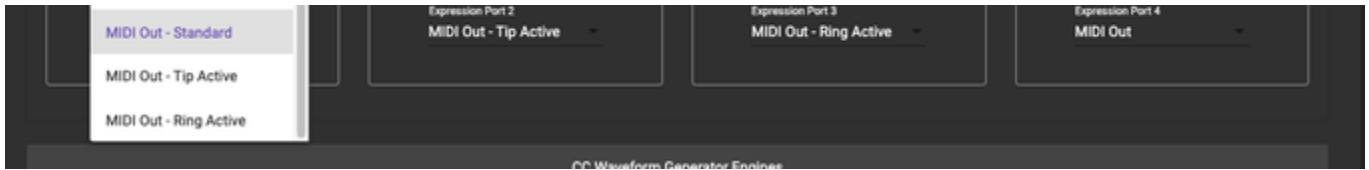

There are 4 MIDI configuration options available:

- MIDI Out : In this setting, MIDI will be sent according to the jumper switch arrangement (see below)
- MIDI Out - Standard : Send MIDI via the Tip and the Ring is powered
- MIDI Out - Tip Active : Send MIDI via the Tip and Ring is unpowered (floating)
- MIDI Out - Ring Active: Send MIDI via the Ring and Tip is unpowered (floating)

#### Changing TRS MIDI Configuration using the internal Jumper Switches

There may be instances that require you to physically change your TRS MIDI configuration by using the internal jumper switches. For example, Chase Bliss Audio pedals require MIDI to be sent via the Ring and the Tip to be disconnected (more on this later).

By default, the Omniports are configured as shown in this photo, sending MIDI data via the Tip and 3.3v power is sent via the Ring.

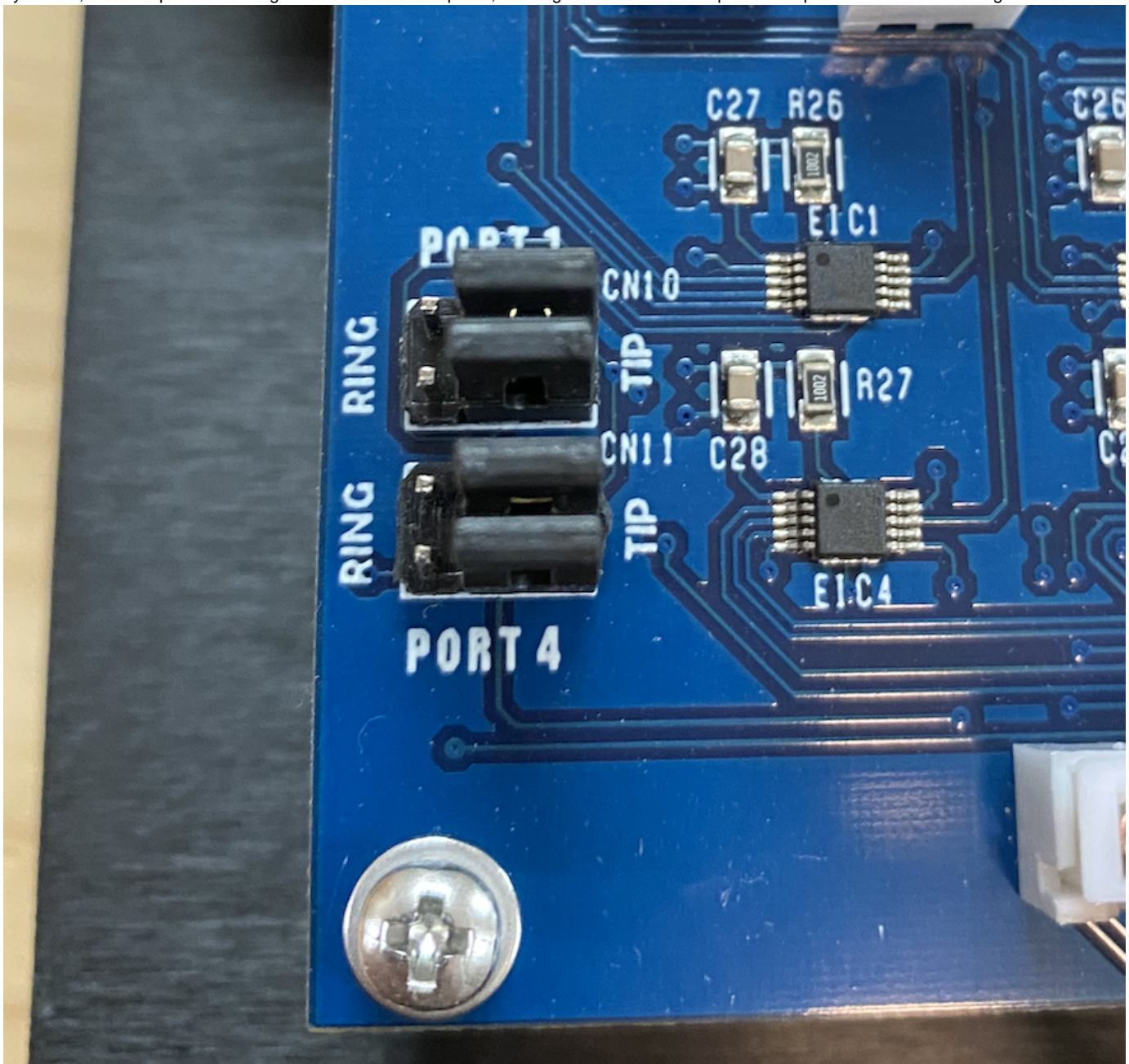

However, devices such as Chase Bliss Audio pedals require a different configuration, where MIDI data is received via the Ring and the Tip is physically disconnected and floating. The MC8 can accommodate this. You will need to remove the back plate of the MC8 and do the following:

⚠ Remove the backplate screws carefully to avoid damage. If you find that the screws are too tight, you should try to loosen the 4 Omniport nuts first before removing the screws.

1. Decide which port you want to configure to control your Chase Bliss pedal
2. Remove the bottom jumper for that port (keep this somewhere safe for future use)
3. Move the top jumper to the left as shown in the photo below

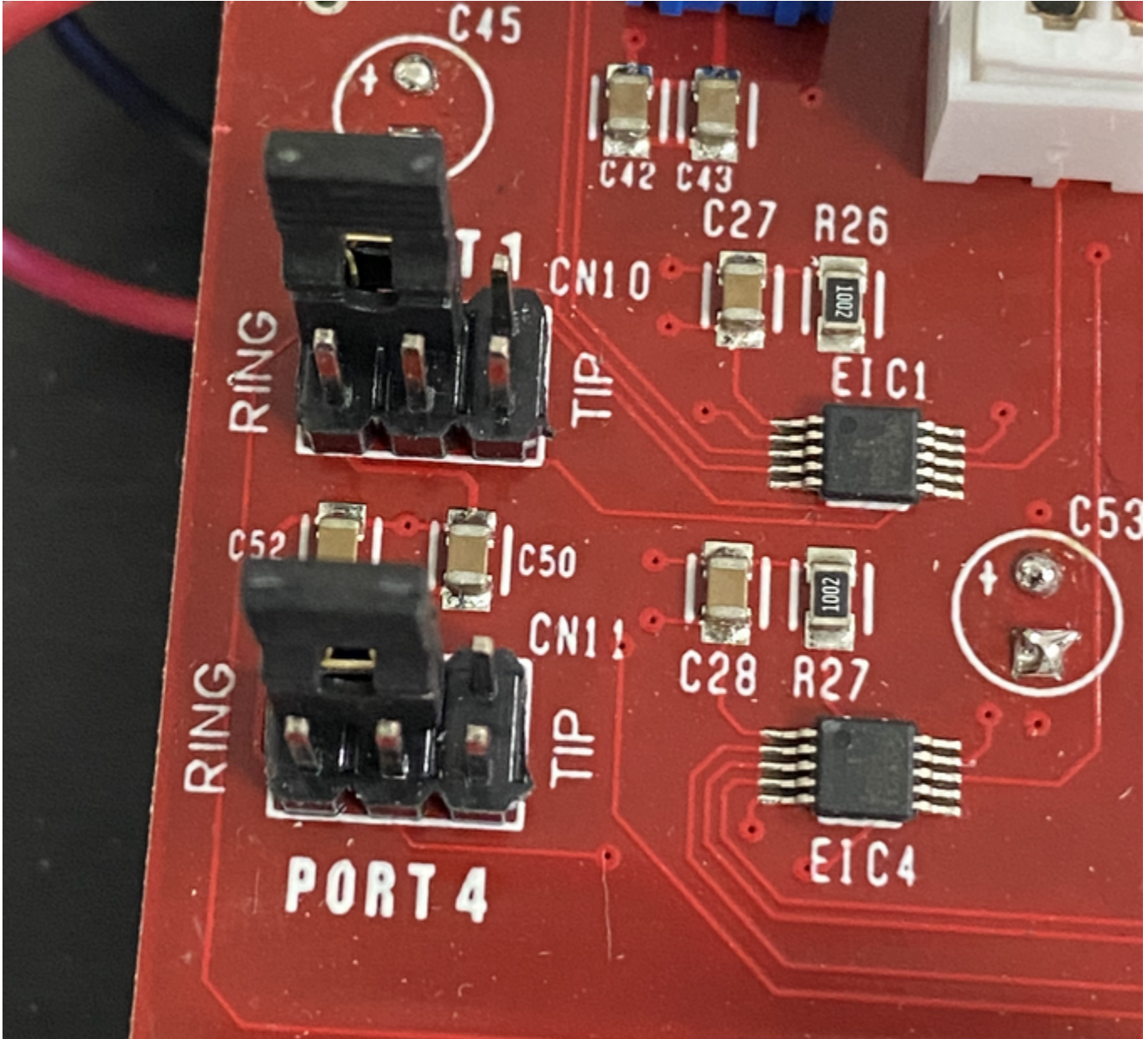

In the image above, ports 1 and 4 are configured to send MIDI to Chase Bliss devices.

For Meris pedals, MIDI data should be sent via the Tip the Ring is physically disconnected and floating as shown by Port 4 in the image below.



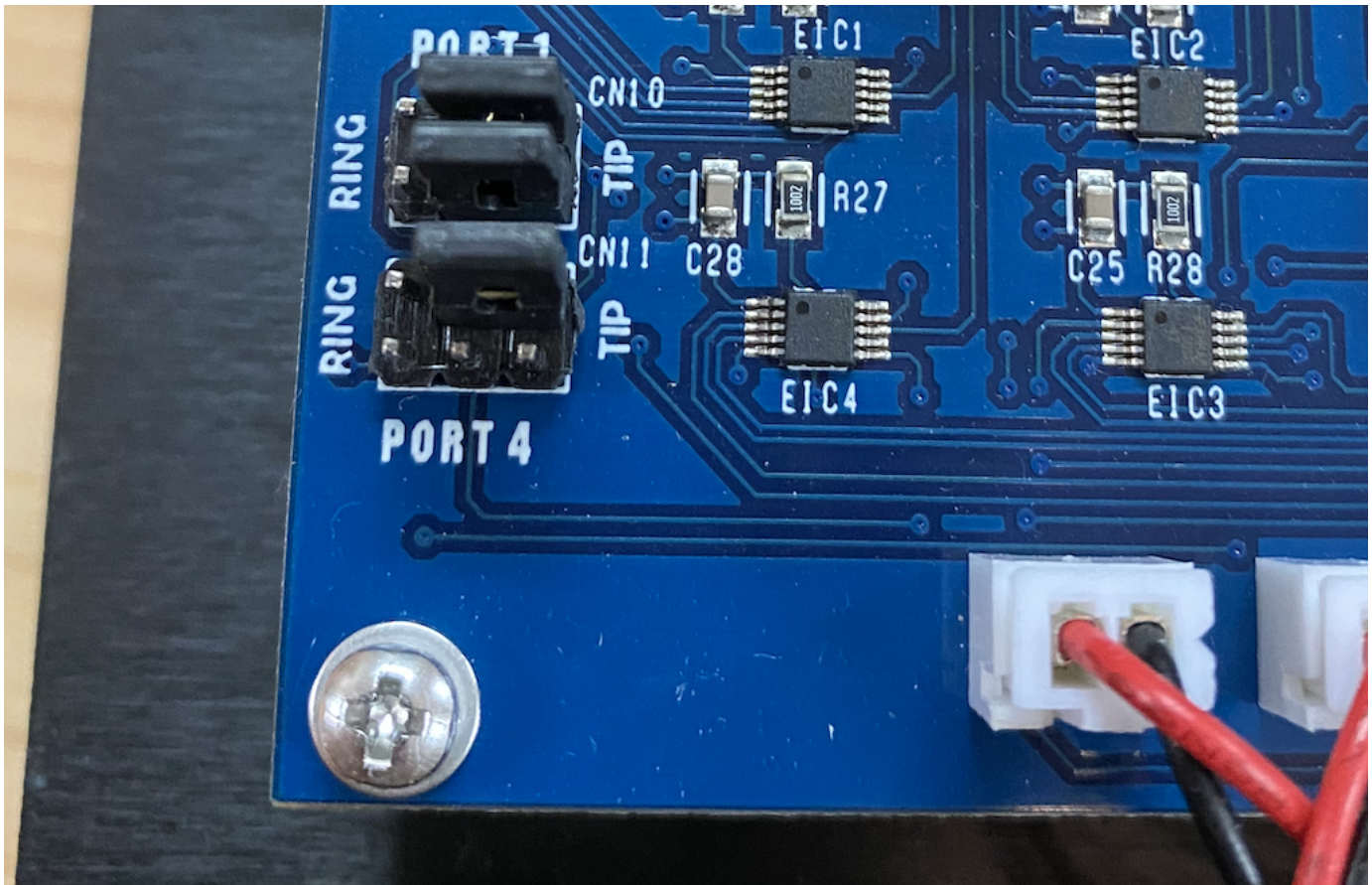

## Copy, Paste and Swap Presets

You can copy, paste and swap presets on your MC8. These options are available on the device itself (press the switch you want to copy, press [E+H] > Preset > Copy, Paste, Swap) and on the Device Editor.

After you have copied your desired preset:

1. Press the switch you want overwrite or swap your copied preset with (it can be from any bank)
2. Press [E+H] > Preset > Paste, Swap
3. Pasting will overwrite the current preset with your copied preset. Swapping will cause your copied preset and current preset to exchange positions.

## Dual Switch Press Functions

Dual switch press combinations allow you to control certain **utility functions** and access **hidden presets** beyond the first 16 presets.

Utility Function	Switches
Bank Down	A+B
Bank Up	C+D
Toggle Page	B+C
Enter Editing Menu	E+H
Toggle MIDI Thru On/Off	A+H
Hidden Preset (on page 1 of each bank)	Switches

Q	E+F
R	F+G
S	G+H

Hidden Preset (on page 2 of each bank)	Switches
T	E+F
U	F+G
V	G+H

## Global Settings

To access the Global Settings Menu, press switches [E+H] and then press Config. The following options will be displayed and you can use the **NextPage** button to scroll through more settings options.

### [MidiClick] - Persistent MIDI Clock

Turn persistent MIDI clock ON or OFF. If persistent MIDI clock is ON, MIDI Clock data will continue to be sent even when you press another switch, change banks or move your expression pedal. If persistent MIDI clock is OFF, MIDI clock data will cease to be sent when an event (like a switch press or expression pedal move) is triggered.

### [Reset] - Factory Reset

To perform a factory reset, hold down for 2 seconds. The display will show that it is performing a factory reset.

 All user presets will be erased and all settings will be reset to factory default.

### [DualLock] - Dual Switch Press Lock

When turned on, dual switch press functions like bank up/down and toggle page will be disabled.

### [Omniport] - OmniPort Settings

Set what each Omniport functions as – MIDI Output, Expression Pedal Input or Aux Switch Input. For more information, please refer to the [Omniports](#) section of this manual.

### [SwthSens] - Switch Sensitivity

Set switch sensitivity. Choose from 1 (least sensitive) to 5 (most sensitive). Pressing switches [B+C] will select level 3 sensitivity. Higher sensitivity means less delay between the time when a switch is pressed and when MIDI messages are sent out.

 By default, sensitivity is set to level 3 and should be comfortable for most users. Depending on personal preference, you may adjust sensitivity to help you bank up/down (by stepping on 2 switches at once) more accurately.

### [MidiChnl] - MIDI Channel

Set the MIDI receive channel for the MC8. The MC8 can receive and respond to MIDI messages from other MIDI controllers. Press Up or Down to select your desired MIDI receive channel.

Press Save to set the channel before exiting.

### [BankArng] - Bank Arrangement

Your banks can be re-arranged in this menu. More info [here](#).

### [MChnlName] - MIDI Channel Names

Name each of your MIDI channels so you know which device each MIDI channel controls.

### [MidiThru] - MIDI Thru

Enable or disable the passing through of MIDI messages received from the MIDI In port through the MIDI Out ports. All MIDI messages types are supported and will be passed through.

### [BankTime] - Bank Display Time

Set the length of time your bank name and number will be displayed whenever you change banks. The unit of measurement is in milliseconds.

### [BnkChgDI] - Bank Change Delay

Adjust the time it takes to load the next bank when the bank is changed. The unit of measurement is in milliseconds.

### [LcdAlign] - Align Switch Names

When turned on, your switch's short name will be auto-aligned, depending on its position on the LCD. For example, switch A's name will be aligned to the left, while switch D's name will be aligned to the right.

### [CrsMdThru] - Cross MIDI Thru

Enable or disable the passing through of MIDI messages received from the 5-pin MIDI input out through the USB port AND the passing through of MIDI messages received from the USB port out through all MIDI outputs.

**i** Not all MIDI message types are supported for Cross MIDI Thru. The supported MIDI message types are **PC, CC, Note, MIDI Clock, Pitch Change** and **After Touch**.

### [IgnreClk] - Ignore Incoming MIDI Clock

If ON, incoming MIDI clock will be blocked and not passed through. If OFF, incoming MIDI clock received from either the USB port or MIDI IN port will be passed through to the MIDI outputs.

### [SvePstTg] - Remember Preset Toggle States Across Banks

Determine whether preset toggle states are remembered across banks even after you have changed banks. If ON, your presets will remain in their last used toggle state even as you scroll through banks. If OFF, your preset toggle states will reset once you exit a bank.

### [LngPrsTm] - Long Press Time

Determine the amount of time (in milliseconds) you need to hold down a switch to trigger a Long Press action.

### [RstBkPst] - Reset Bank Presets

This resets all the Bank Presets to be empty.

---

## Useful Concepts and Features

There are many special functions and features on the controller to help you achieve your desired workflow. We have documented these concepts and features under [Concepts and Features](#)

- [Adding PC Scroll Numbers to your Preset Short / Toggle Name](#)
- [Looper Mode for Zero-latency Looper Control](#)
- [Preset Message Scroll \(scroll through messages within a preset\)](#)
- [Custom Bank Sequence](#)
- [CC Waveform Generators](#)
- [CC Sequencer Generators](#)
- [Toggle Switch Mode \(send different MIDI messages with each alternate press\)](#)
- [Sending incremental/decremental PC numbers or CC Values](#)
- [Using Strymon Nixie with Morningstar Controllers](#)
- [Using a Bluetooth MIDI adaptor to connect with the Editor \(CME WIDI\)](#)
- [Using the Web Editor on a Mobile Device](#)
- [Bank Presets \(send MIDI messages upon entering or exiting a bank\)](#)

---

## Update Firmware

We regularly update our controllers' firmware to introduce new features, improve performance and fix bugs.

**i** Watch video tutorial <https://youtu.be/wtvX8Y9LzXo>

## How to Update your Firmware

1. To update your Morningstar controller firmware, you first need to download the **Morningstar Firmware Updater** from the [Morningstar website](#) in the 'Downloads' section. Both Mac OS and Windows versions are available. Just download the correct version for your operating system. Download the Firmware Uploader [here](#).

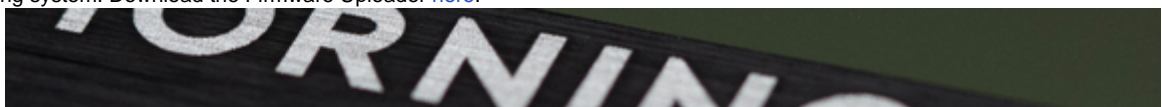

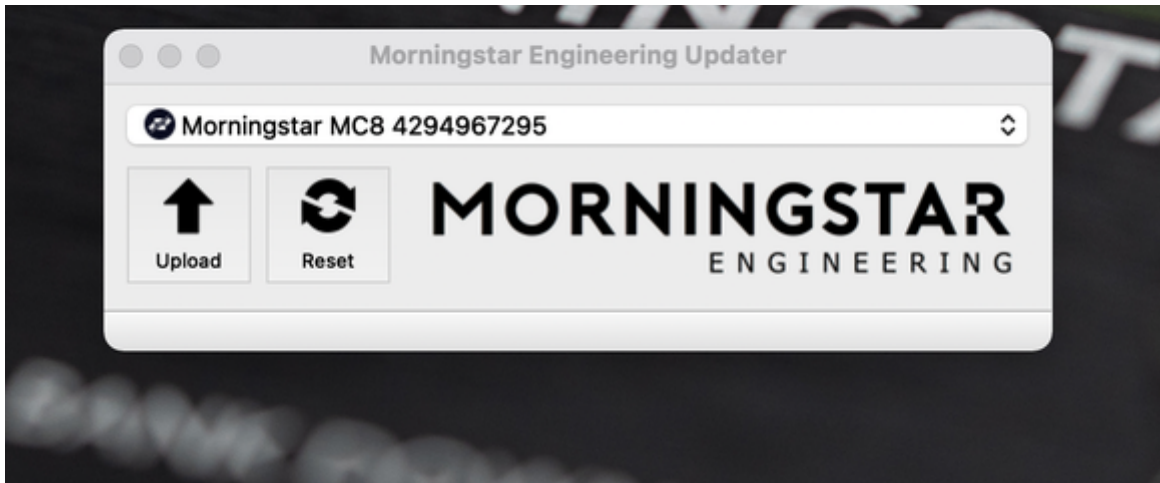

2. Install the Firmware Updater on your computer. If you are on Mac OS, you may need to go into your security and privacy settings and click on Open Anyway to allow the application to be installed.
3. After you've installed the Firmware Updater, you'll need to **download the latest firmware**, also found under the 'Downloads' section on the Morningstar Website. Download the latest MC8 firmware [here](#)
4. Once you've downloaded it, **launch the Morningstar Firmware Updater and connect your MIDI controller to your computer via USB**. Your controller will automatically be recognised by the Updater.
5. Click on the Upload button and open the new firmware .hex file from your downloads folder. The firmware update will begin automatically and your controller will restart. That's it!

### Unsuccessful Firmware Update

In the rare event where your device upload is not successful, the device might appear to be bricked with blocks showing across the LCD screen. Do not worry and follow these steps:

1. Download the latest firmware from our website.
2. Remove the back cover for your device and locate the reset button.
3. While the device is connected to your computer via USB, and with the Firmware Uploader open, press the reset button location on the PCB.
4. Once pressed, the Firmware Uploader should detect the device. Thereafter, repeat the above upload procedure.

## Using an External MIDI Controller to control the MC8

The MC8 can be controlled by external MIDI controllers, via both its MIDI input and USB port.

### MIDI Implementation Charts

#### PC Messages

PC messages will change the banks on the MC8, where a PC#0 message will engage Bank 1, and PC#1 message will engage Bank 2, and so on.

#### MIDI PC Implementation Chart

PC#	Bank
0	1
1	2
2	3
.	.
.	.



.	.
29	30

### CC Messages

CC messages allow you to navigate through the MC8's banks, engage presets and clear toggle states.

#### MIDI CC Implementation Chart

Function	CC#	Value
Bank Up	0	any
Bank Down	1	any
Set Toggle (All)	2	127
Set Toggle (Individual)	2	0 = Preset A 1 = Preset B 2 = Preset C . . . 21 = Preset V
Clear Toggle (All)	3	127
Clear Toggle (Individual)	3	0 = Preset A 1 = Preset B 2 = Preset C . . . 21 = Preset V
Toggle Page	4	any
Engage Preset	10 = Preset A 11 = Preset B 12 = Preset C . . . 31 = Preset V	0 = Do Nothing 1 = Press 2 = Release 3 = Long Press 4 = Long Press Release 5 = Double Tap 6 = Double Tap Release 7 = Double Tap Hold 8 = Double Tap Hold Release 9 = Release All 10 = Long Press Scroll
Set MIDI BPM (MSB 2 bits)	5	0-127
Set MIDI BPM (LSB 7 bits)	6	0-127
Engage Expression 1	51	0-127
Engage Expression 2	52	0-127
Engage Expression 3	53	0-127
Engage Expression 4	54	0-127