

v3.6

Table of Content

- 1 Table of Content
- 2 Version
- 3 Status
- 4 Overview
 - 4.1 Saving the manual as PDF
- 5 Glossary
- 6 Important things to note
 - 6.1 Editing your presets in the editor
 - 6.2 Entering Edit Menu
- 7 Design and Architecture
- 8 Hardware Overview
 - 8.1 Powering the MC6
 - 8.2 Connections
 - 8.2.1 MIDI In/Receive
 - 8.2.2 MIDI Out/Send/Thru
 - 8.2.3 USB port
 - 8.2.4 EXP 1 & 2
- 9 Using External Aux Switches
- 10 Using Expression Pedals
- 11 Global Configuration Menu
 - 11.1 Factory Reset - Reset
 - 11.2 Set MIDI Channel - MidiCh
 - 11.3 Change Expression Input - Explnpt
 - 11.4 Switch Sensitivity - SwSens
 - 11.5 Bank Display Time - BnkTime
 - 11.6 Bank Change Time - BnkChgDelay
 - 11.7 MIDI Clock - MidiClk
 - 11.8 Align Short Name - LcdAlign
 - 11.9 Lock dual switch presses - DualLock
 - 11.10 Re-arrange Banks - BankArng
 - 11.11 Save Preset Toggle - SvePstTg
 - 11.12 Long Press Time - LngPrsTm
- 12 General Usage
 - 12.1 Changing Banks
 - 12.2 Switch and Display Names
 - 12.3 Mapping Actions to Midi Types
 - 12.4 MIDI Thru
 - 12.5 Editing Presets
 - 12.6 Copying, Pasting and Swapping Presets
 - 12.7 Dual Switch Functions
- 13 Editing the MC6
 - 13.1 Edit Menu
 - 13.1.1 To enter the Edit Menu
 - 13.1.2 Edit Menu
 - 13.2 Programming Presets
 - 13.2.1 Preset Edit Menu
 - 13.3 Editing Preset Messages
 - 13.3.1 Selecting a Message to Edit
 - 13.3.2 Edit Action
 - 13.3.3 Edit Toggle Position
 - 13.3.4 Edit Type
 - 13.3.5 Edit Type Parameters
 - 13.4 Toggle Mode

- 13.4.1 Using the Web/Desktop Editor
 - 13.4.1.1 How it works
 - 13.4.1.2 Toggle Name
 - 13.4.1.3 Blinking
- 13.4.2 Using the built-in MC6 editor
- 13.5 Editing Expression Messages
 - 13.5.1 Expression Edit Menu (Page 1)
 - 13.5.2 Expression Edit Menu (Page 2)
 - 13.5.3 Edit Full Name
 - 13.5.4 Calibrating your Expression Input
 - 13.5.5 Setting your Expression sensitivity
- 14 Editing Bank Settings
- 15 Editing Names
- 16 MIDI Editor
 - 16.1 Connecting the device
 - 16.2 Editing Functions
 - 16.2.1 Device Control Functions
 - 16.3 Preset Editing Options
 - 16.4 Message Editing Options
 - 16.5 Backing Up Your Data
 - 16.6 Naming your MIDI Channels
- 17 Firmware Update
 - 17.1 What to download
 - 17.2 Upload instructions
- 18 Troubleshooting
- 19 MIDI Implementation
 - 19.1 PC Messages
 - 19.2 CC Messages

Version

3.6.1

Status

PROD

Overview

In Firmware version 3.6. we made changes to the Web Editor, and the way the MC6 interacts with it. Hence, when upgrading to the this version, please make sure that you are using the new Web Editor as well.

We take pride in making the device one of the easiest-to-use programmable MIDI controllers in the market. If there is any questions you have using the device, please do not hesitate to drop us an email at help@morningstarfx.com.

Saving the manual as PDF

There is an icon at the top right of this page. Clicking on it will bring out a menu with an option to export the page as a PDF document.



MC6 MKII Manual



Created by James Toh
Last updated 10 minutes ago

Table of Content

- 1 Table of Content
- 2 Overview
- 3 Important things to note
 - 3.1 Editing your presets in the editor
- 4 Design and Architecture
- 5 Hardware Overview

Attachments (32)

Page History

Page Information

Resolved comments

Link to this Page...

View in Hierarchy

View Source

Export to PDF

Export to Word

Glossary

Important things to note

Editing your presets in the editor

:movie_camera: Video tutorial available here: <https://youtu.be/NEI0EievXd0>

Make sure you are in Editor mode. Press Switch [C + D] to enter editor mode or click the Toggle Edit Mode button on the editor.

Entering Edit Menu

Press Switch [D + F] in the main preset page. The last used preset, expression pedal input and bank will be displayed in the menu.

Make sure to exit Editor mode to have the full functionality available before you use it with your devices.

Design and Architecture

The MC6 MKII is a fully programmable MIDI controller, capable of controlling up to 16 MIDI devices per switch.

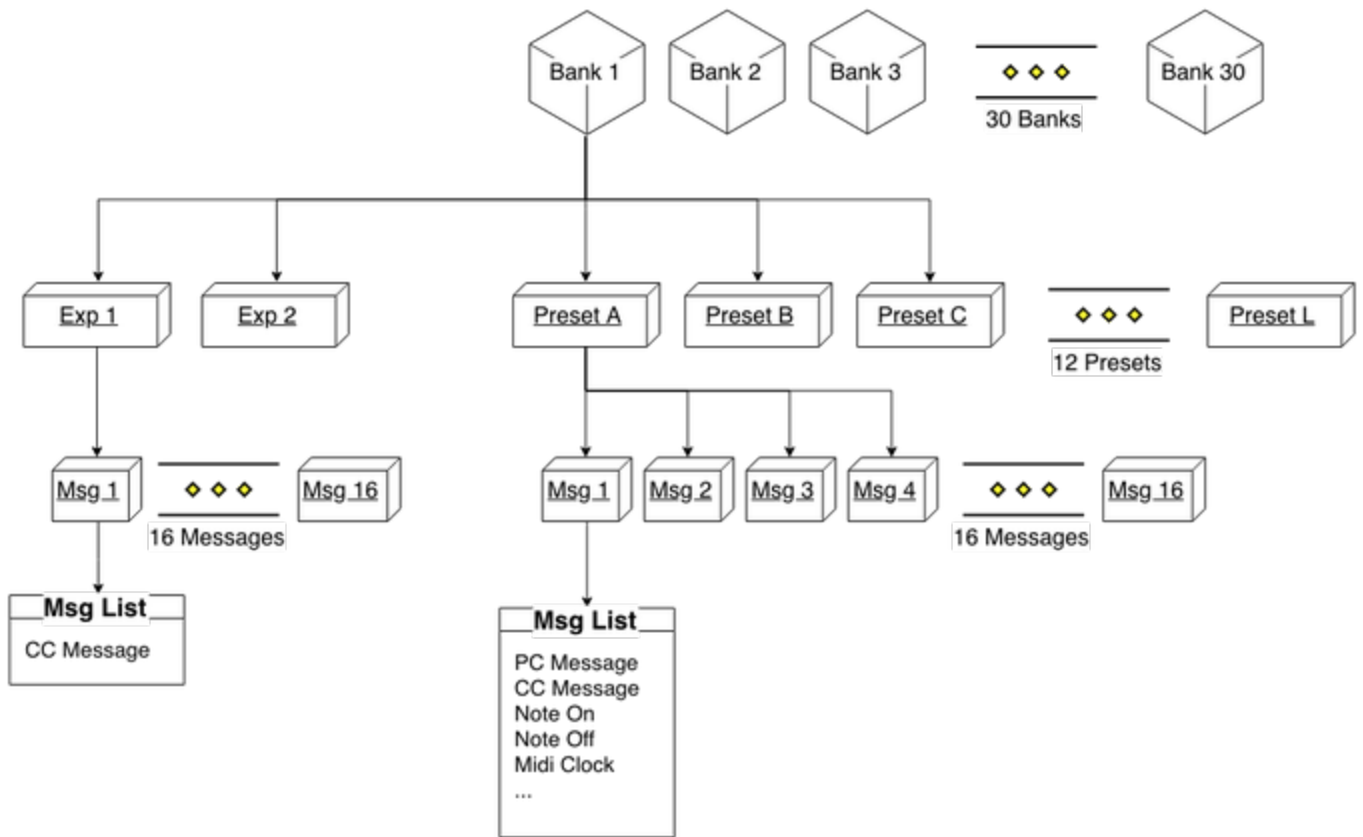

There are 30 banks. Each bank has 12 presets and 2 expression presets. Each preset can be programmed to send out 16 different messages.

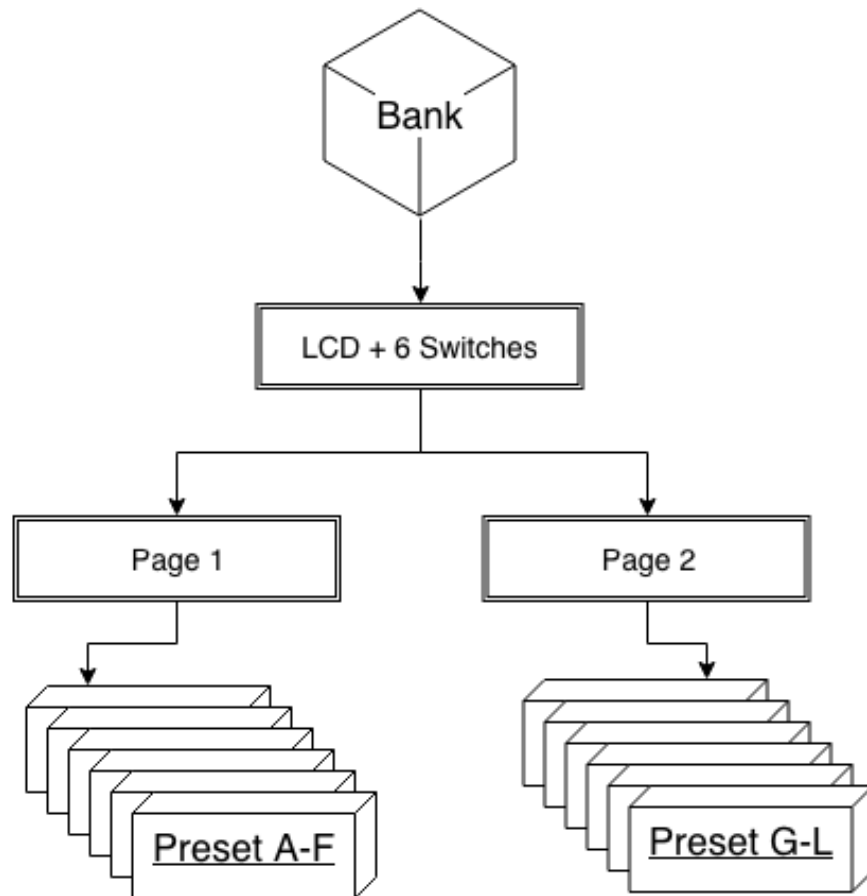

Each bank can display up to 6 presets, of which all are accessible from the 6 switches. The other 6 presets can be engaged via dual switch presses or external aux controllers. A Page Toggle function is also available to switch between the first 6 presets and the last 6 presets.

Hardware Overview

Powering the MC6

Your MC6 MKII device can be powered via the following methods

9VDC Centre Negative power supply

Connect a 9VDC centre negative power supply to the power input of the MC6.

Phantom Power (9-12v AC or DC)

Connect a 7-pin Midi cable to the MIDI OUT port of the MC6. Phantom power is supplied through pins 6 and 7. Phantom power is chained to pins 6 & 7 on the MIDI IN port as well, allowing you to power other devices.

If sending DC power via the pins, the polarity does not matter.

USB power

Connect a USB cable to the MC6. The MC6 is capable of being fully powered by USB.

The device requires a power supply of at least 80mA at 9VDC

Connections

Information on all the inputs and outputs on the MC6.

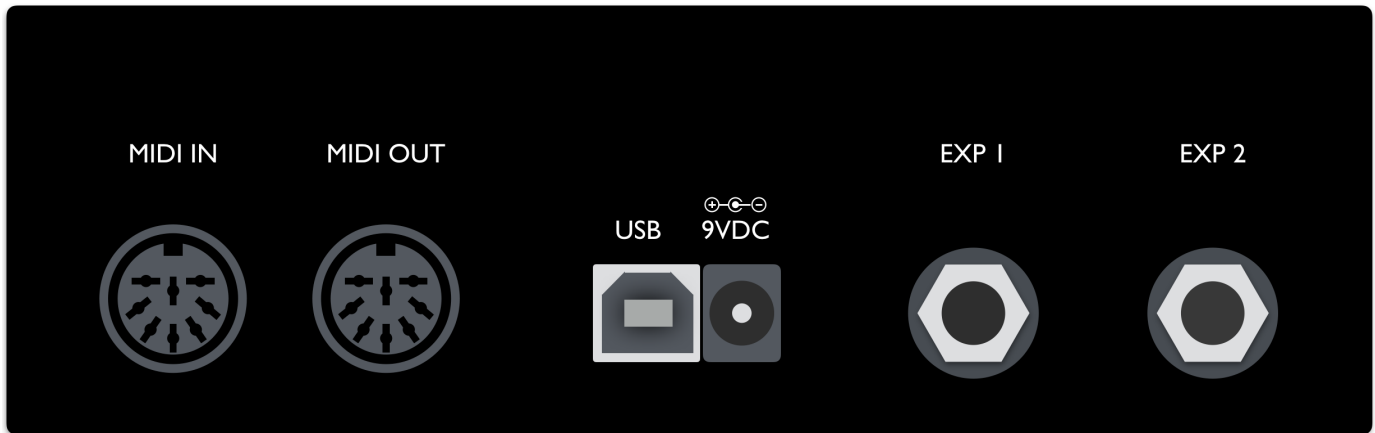

MIDI In/Receive

This is where the MC6 receives MIDI messages from other MIDI devices.

The MC6 passes incoming MIDI messages via the MIDI In/Receive port out to the USB port, and vice versa.

MIDI Out/Send/Thru

This is where MIDI data is sent from the MC6 to other devices. You can use a standard 5-pin MIDI cable, or a 7-pin one if you want to power the MC6 with phantom power. The MC6 also has MIDI THRU, which allows incoming MIDI messages to be relayed to other MIDI-capable devices.

USB port

The MC6 can also send and receive MIDI data via USB, allowing you to have control over your DAWs and music software. It is class compliant and compatible with Windows, macOS, Android and iOS.

The MC6 passes incoming MIDI messages via the MIDI In/Receive port out to the USB port, and vice versa.

EXP 1 & 2

You can connect your expression pedals to these ports to control the expression presets, or connect aux switches to add more programmable switches to the MC6.

Please note that these ports are **INPUT** only, and cannot be used to control functions like amp switching or sending Control Voltage messages. You should only be connecting an expression pedal or TRS passive Aux Switches to these ports.

You should only use **STEREO CABLES**. Using Mono cables will cause the device not to work as intended.

Please do not apply any power to these inputs!

Using External Aux Switches

You can connect an external Aux switch to your MC6 to control Presets G - L.

The MC6 requires an aux switch that is wired to work with the Eventide H9. It has to be connected to the MC6 with a stereo cable, where the Tip is connected to the ground via a footswitch, and similar to the Ring as well. Another switch can be added to connect both Tip and Ring to ground to engage an additional preset/setting. Please refer to the schematic below.

There are a few pedal builders that sell such devices:

Analog Endeavors

American Loopers

Please note that we are in no way affiliated with these companies.

If you would like to build one yourself, you can refer to the following schematic:

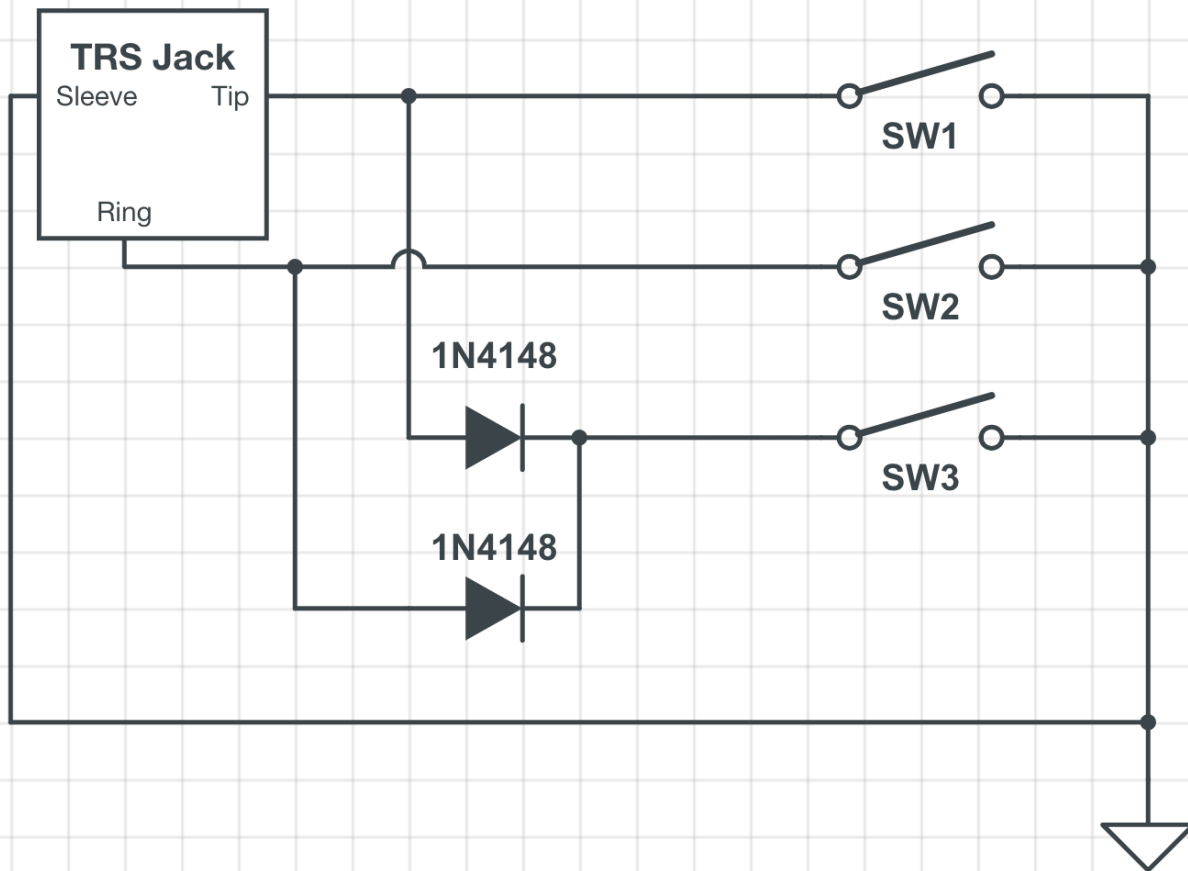

Using Expression Pedals

:movie_camera: Video tutorial available - <https://youtu.be/-TNTkqh-gEE>

The MC6 work with TRS expression pedals. It works best with expression pedals with fitted 10k - 25k linear potentiometers. The potentiometer wiper should be connected to the Tip of the stereo cable, while the Ring and Sleeve should be connected to the outer lugs on the potentiometer.

When connecting a new Expression pedal, be sure to calibrate it first by going into the Edit menu (Switch D+F), selecting `Exp1` or `Exp2` and then `Calibrte`.

Global Configuration Menu

To access the Controller Settings Menu, hold down `Switch D` before powering up the MC6. This menu allows you to edit the global settings for the device.

The Main Configuration Menu can also be accessed by going into the Edit Settings page (`Switch D + F`) and selecting `GblConfig`.

Please note that the controller will restart after exiting the Main Configuration Menu.

The display will indicate that it is booting into the configuration page.

Factory Reset - `Reset`

To do a factory reset, hold down the Reset switch for 2 seconds. The MC6 will show that it is performing a factory reset. All user presets and settings will be reset to factory default when a reset is done.

:exclamation:**You will lose all saved presets and settings!**:exclamation:

Set MIDI Channel - `Midich`

Set the MIDI receive channel for the MC6. The MC6 can receive and respond to messages from external midi controllers. Press Switch A or B to increase or decrease the MIDI channel respectively.

Press `Save` to save your settings and `Exit` to exit.

Change Expression Input - `ExpInpt`

Change the device Expression Input Type and select between **Aux Switch**, **Expression**, **Fixed Sw 1**, **Fixed Sw 2** Setting.

- **Aux Switch**: Use a stereo cable to connect to an external aux switch to control more presets.
- **Expression**: Connect an expression pedal via a stereo cable (Tip connected to wiper) to engage the expression preset.
- **Fixed Sw 1**: Similar to the aux switch, but the functions are hard-coded to control the Bank Up, Bank Down and Toggle Page functions without sacrificing any presets.
- **Fixed Sw 2**: Similar to the Fixed Sw 2, but with the Bank up and down reversed.

Switch Sensitivity - `SwSens`

Set switch sensitivity. Choose from 1 (least sensitive) to 5 (most sensitive). Pressing `Switch A+B` will select 2, while `Switch B+C` will select 4.

By default, this is set to 3 and should be comfortable for most users. Depending on personal taste, you may adjust sensitivity to help you bank up/down (by stepping on 2 switches at once) more accurately.

More sensitive means that the lag between the time when a message is sent out and when the switch is pressed it at its minimum.

Bank Display Time - `BankTime`

This setting adjusts the amount of time the bank details will show when the bank is changed.

The value displayed is in milliseconds.

Bank Change Time - `BankChgDelay`

This setting adjusts the time it takes to load the next bank when the bank is changed.

The value displayed is in milliseconds.

MIDI Clock - `Midiclk`

The MIDI clock setting toggles the persistent MIDI clock function **ON** and **OFF**. This setting is related to the MIDI Clock message under MIDI Types. If persistent MIDI is **ON**, the MIDI Clock message will continue sending a MIDI clock signal when engaged, even when engaging other presets or scrolling through banks. However, if persistent MIDI is **OFF**, the MIDI clock signals will shut off when an event (like a switch press or expression pedal move) is triggered.

Align Short Name - `LcdAlign`

When `LcdAlign` is turned on, your Preset Short Names will be aligned, depending on its position on the LCD. For example, Preset A name will be aligned to the left, while Preset C name will be aligned to the right.

Lock dual switch presses - DualLock

When the dual lock setting is turned on, dual switch press functions like Bank Down, Bank Up and Toggle Page will be disabled.

Re-arrange Banks - BankArng

Your banks can be re-arranged in this menu. More info [here](#).

Save Preset Toggle - SvePstTg

Determines whether the preset toggle position will be saved when you change bank. If set to ON, your preset toggle positions will be saved and loaded when you change banks. When set to OFF, your preset toggle positions will be reset back to default when the bank is changed.

Long Press Time - LngPrsTm

Sets the amount of time (in milliseconds) you need to hold down the switch in order to trigger a Long Press action.

General Usage

Changing Banks

Step on Switches A+B together to bank down and Switches B+C to bank up. There are a total of 30 banks on the MC6 MKII.

Bank Changes can also be executed by programming a Bank Change function to a preset, or by using an External Aux Switch.

Switch and Display Names

Each switch corresponds to the display name closest to it. Pressing Switch A activates Preset A, Switch B activates Preset B and so forth.

Mapping Actions to Midi Types

The MC6 MKII allows you to map actions taken on the switches to MIDI Types and functions. For example, you can map a CC#1 message to a Press action, and a CC#2 message to a Release action. When the switch is pressed, a CC#1 message will be sent, and when the switch is released, a CC#2 messages will be sent. There is a list of actions available to you.

1. Press
2. Release
3. Long Press
4. Long Press Release
5. Double Tap
6. Double Tap Release
7. Long Double Tap
8. Long Double Tap Release
9. Release All

More information can be found in the Action Glossary .

MIDI Thru

The MC6 MKII can be programmed to pass incoming MIDI signals from the MIDI IN port to the MIDI OUT port. It can also pass CC, PC and Note messages thru to the USB port. The MC6 MKII will also pass incoming CC, PC and Note MIDI signals from the USB MIDI port to the MIDI OUT port.

You can toggle this setting on and off by pressing Switches A+F together.

Editing Presets

Both the Switch Presets and Expression Presets on the device can be edited via the **on-board editing functions** or the **Web/Desktop Editor**.

Copying, Pasting and Swapping Presets

The device allows copying and pasting of presets into different presets. These options are available in the device itself (D+F >> Preset >> Copy, Paste, Swap).

Dual Switch Functions

The MC6 MKII makes use of dual switch combination to carry out certain functions.

Function	Switch
Bank Down	A+B
Bank Up	B+C
Edit Menu	D+F
Toggle Editor Mode	C+D
Toggle MIDI Thru	A+F

Besides this, you can also use dual switch presses to call the extra presets.

Preset	Switch
G	D+E
H	E+F
I	A+D
J	B+E
K	C+F

Editing the MC6

The MC6 MKII can be programmed on the device itself, or by using the Web/Desktop Editor.

Edit Menu

On a new controller, all switches are initially labelled as `EMPTY`. It is up to you to decide exactly what each one will do.

To enter the Edit Menu

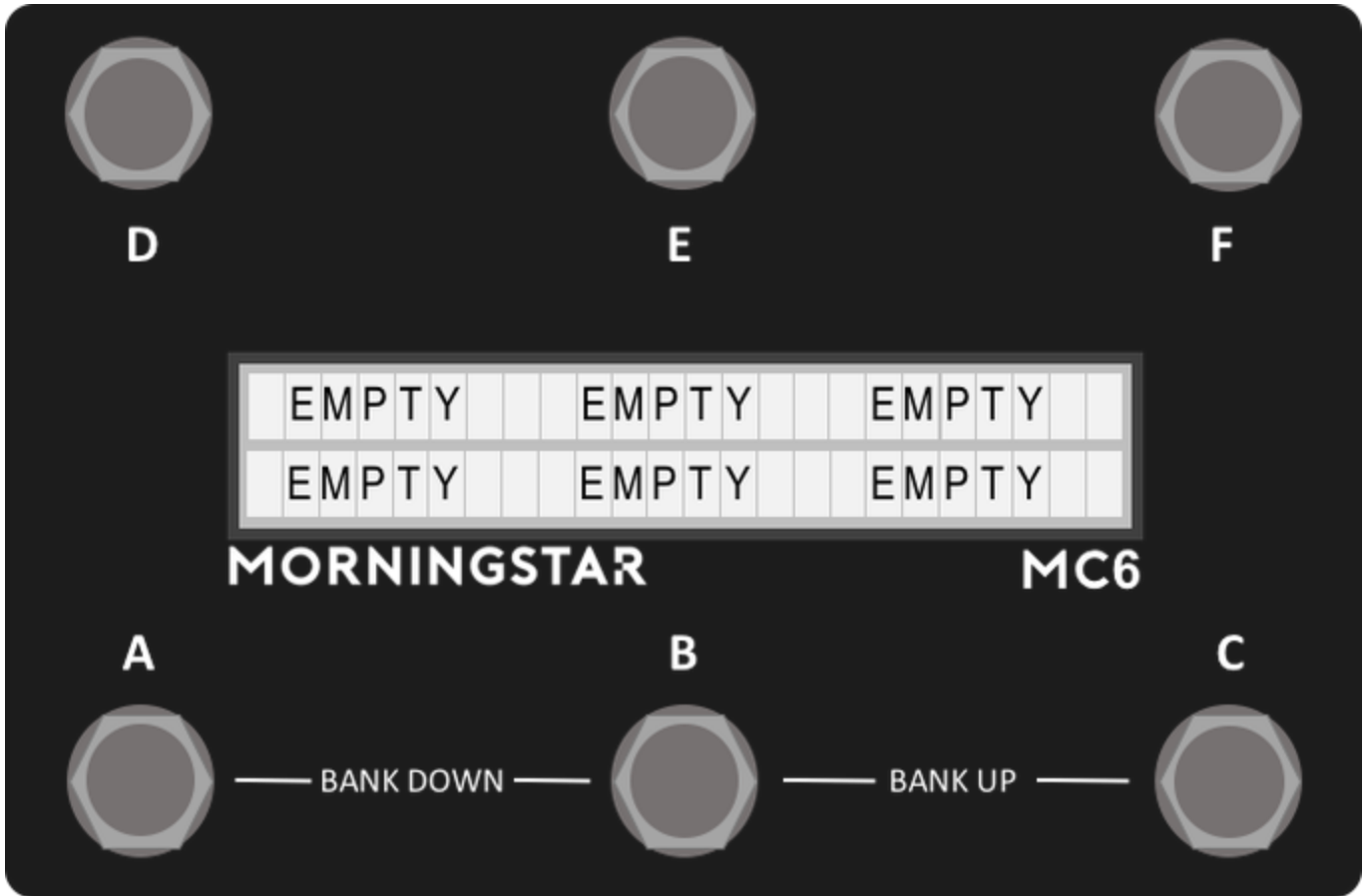

1. Press the switch you wish to program
2. Press Switches [D + F] together. This will take you to the Edit Menu shown below.

Edit Menu

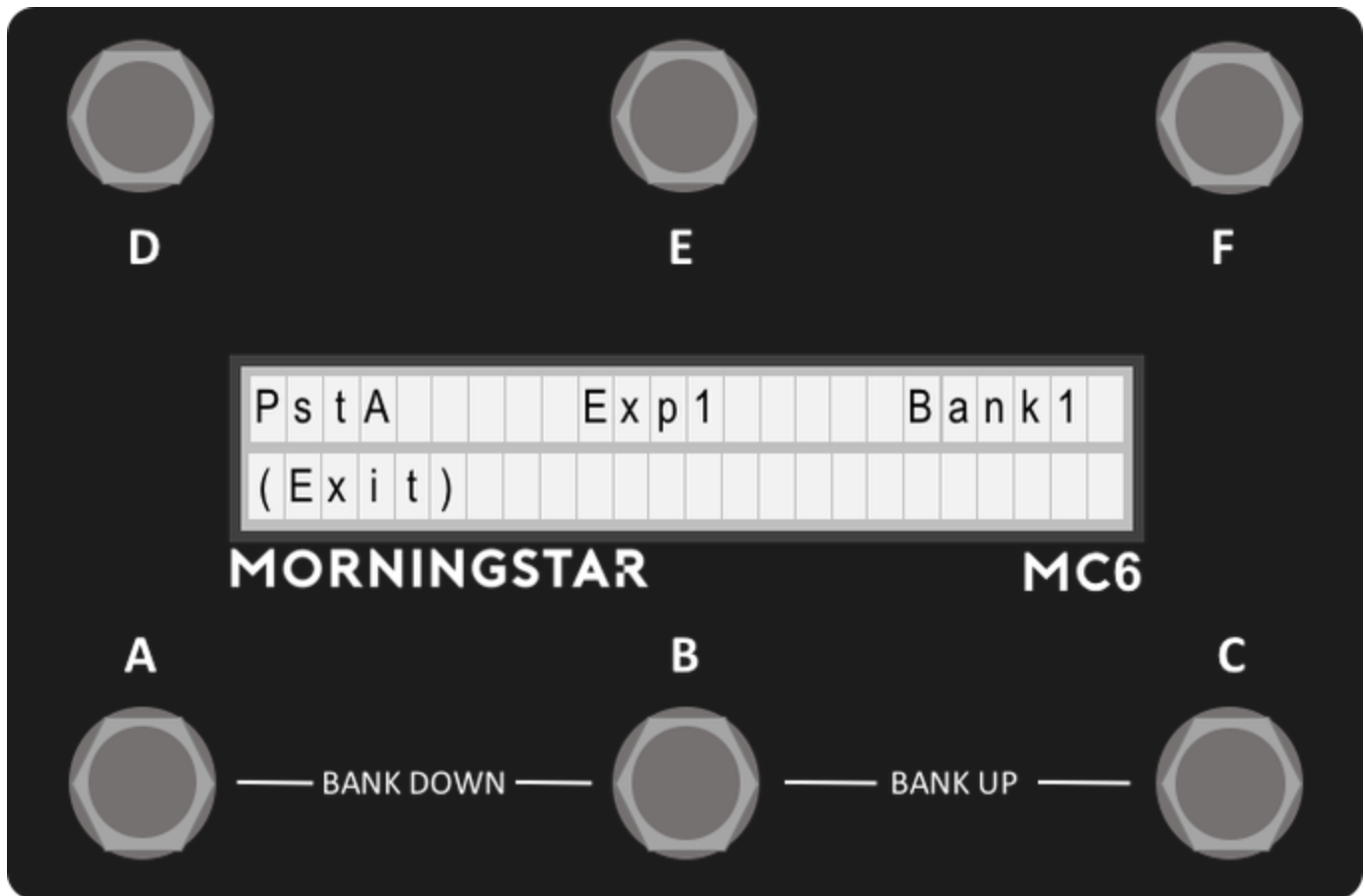

After pressing **Switches [D + F]**, the Edit menu will be displayed. The preset and expression you last used will be displayed, as well as the bank you are currently on.

Press **Switch D** to edit the preset, **Switch E** to edit the expression preset, or **Switch F** to edit the bank.

Programming Presets

Upon pressing Preset in the Edit Menu, you will be directed to the Preset Edit page.

Preset Edit Menu

Msg - Edits the 16 Midi Messages available in the preset.

ClrPrest (Clear Preset) - Clear the preset settings.

Copy - Copy the preset settings

Paste - Paste the copied preset settings to the currently selected switch.:exclamation: Holding down 'Paste' will paste the copied preset settings to all banks.

Swap - Swaps the current preset with the last copied preset

ShrtNme (Short Name) - Edits the preset short name. Look at Editing Names for more information on how to edit any names in the MC6.

ToggNme (Toggle Name) - Edits the preset toggle name. Look at Editing Names for more information on how to edit any names in the MC6.

FullNme (Full Name) - Edits the preset full name. Look at Editing Names for more information on how to edit any names in the MC6.

Toggle - Toggles between On and Off for the preset toggle setting. If On, each time the preset is engaged, the toggle position of the preset will change. The Midi Messages in the preset will rely on the toggle position of the preset to determine if it should be invoked.

Blink - Toggles between On and Off for the preset blink setting. If On, the preset short name will blink when the preset toggle is in the engaged position. This is useful to visually determine the toggle state of your preset.

(Exit) - Exits the menu.

Editing Preset Messages

The MC6 has 16 Messages in each Preset.

Selecting a Message to Edit

When you enter the Edit Msg interface, the screen above will show. In this screen, you can view the current Midi Type that is assigned to that message. It also indicates the current message that is selected for editing. Pressing Next will allow you to edit the selected message.

Edit Action

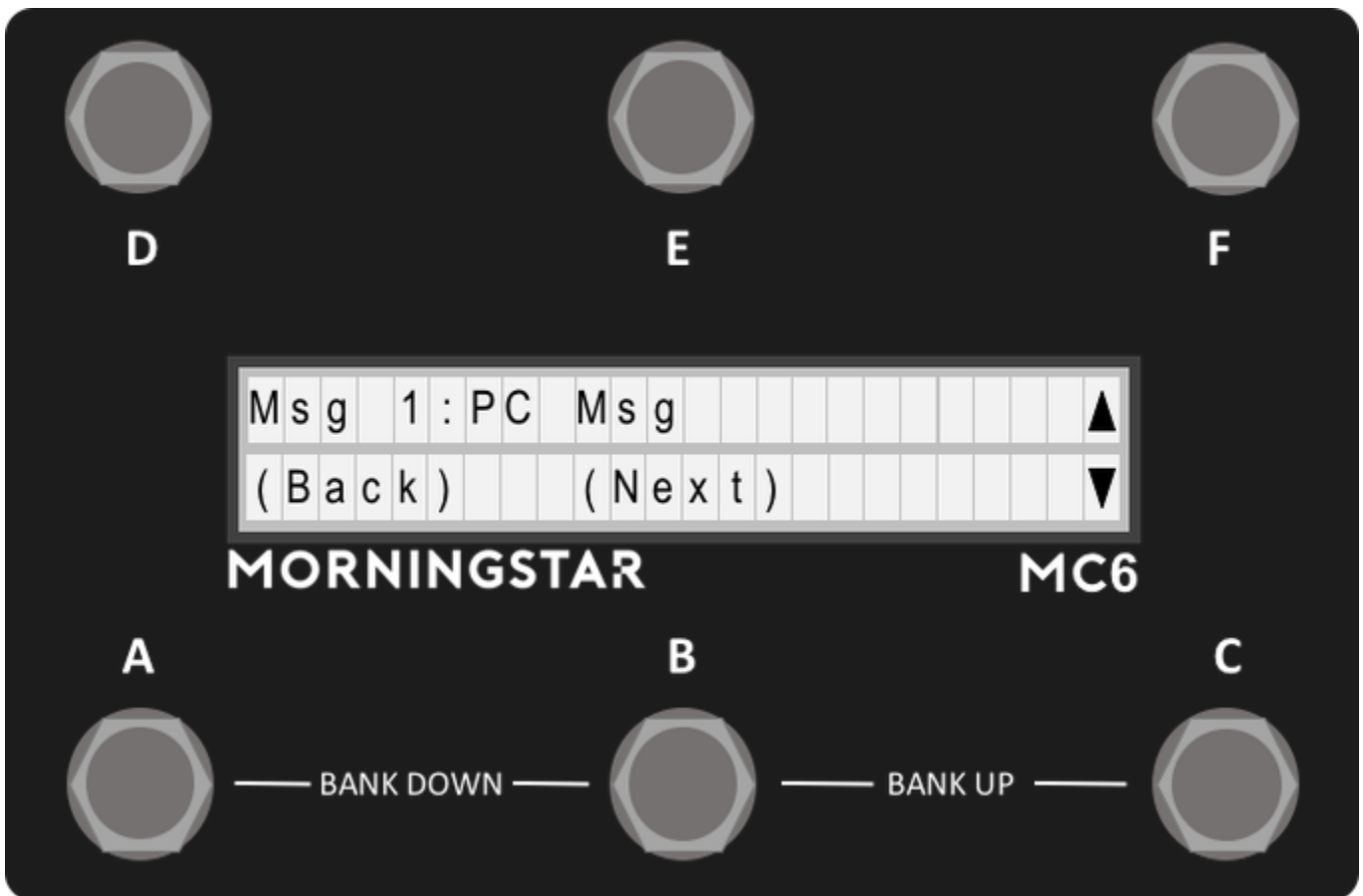

The next menu allows you to select the action to assign to the message. Once selected, each time that action is carried out on the corresponding preset switch, only the messages assigned to that action will be invoked.

Edit Toggle Position

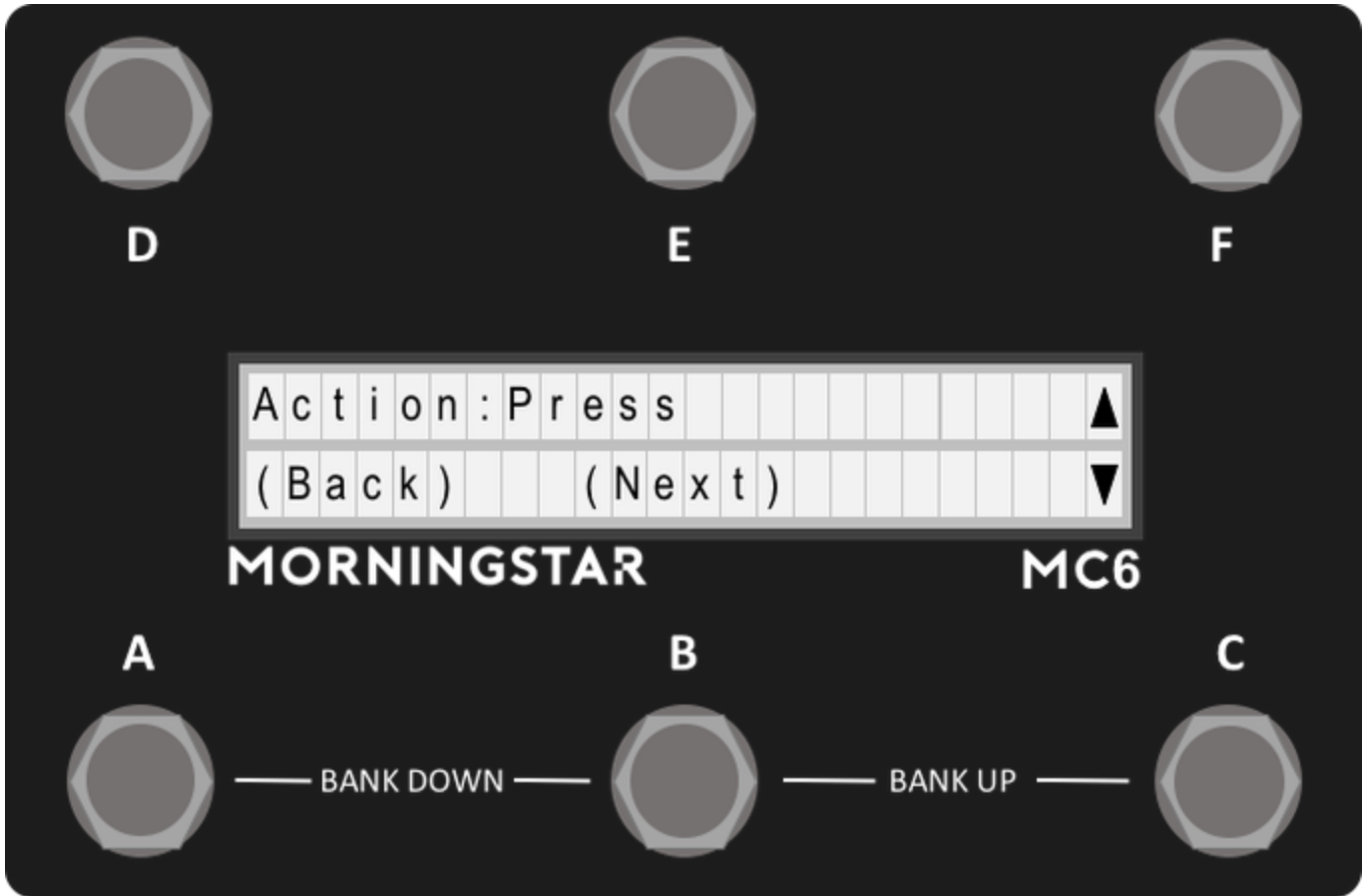

The next menu allows you to edit the message toggle position. Select between On and Off. This allows only the messages that match the current preset toggle position to be invoked.

From firmware 3.2.1 onwards, this feature has changed to toggle positions 1, 2 and Both. Toggle position Both will have the message sent in both toggle positions.

Edit Type

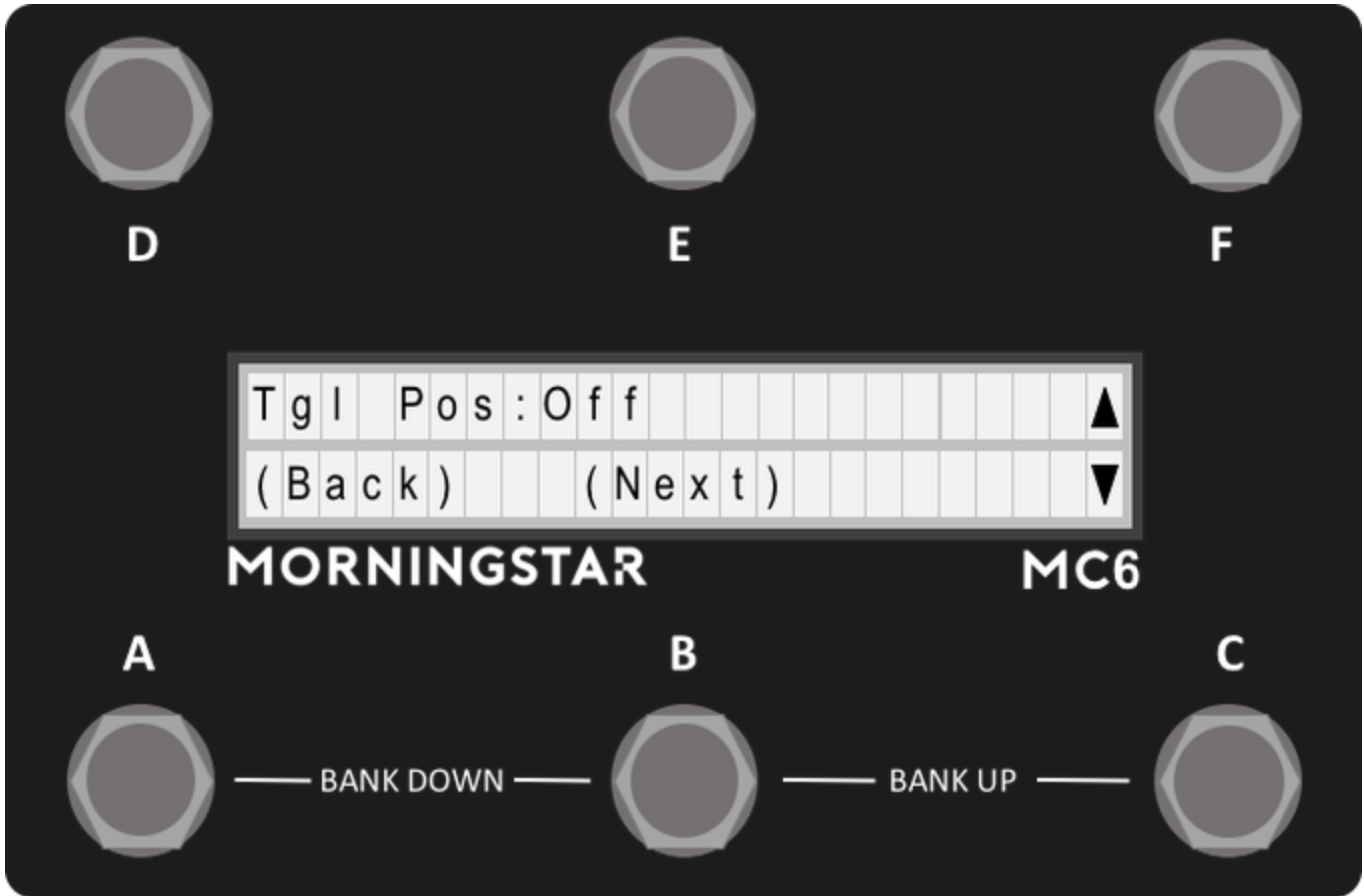

The next menu allows you to edit the Message Type. Scroll up and down to select the Midi Type that you want to be associated with the message. You can read about the full list of Midi Types available in the Glossary.

Edit Type Parameters

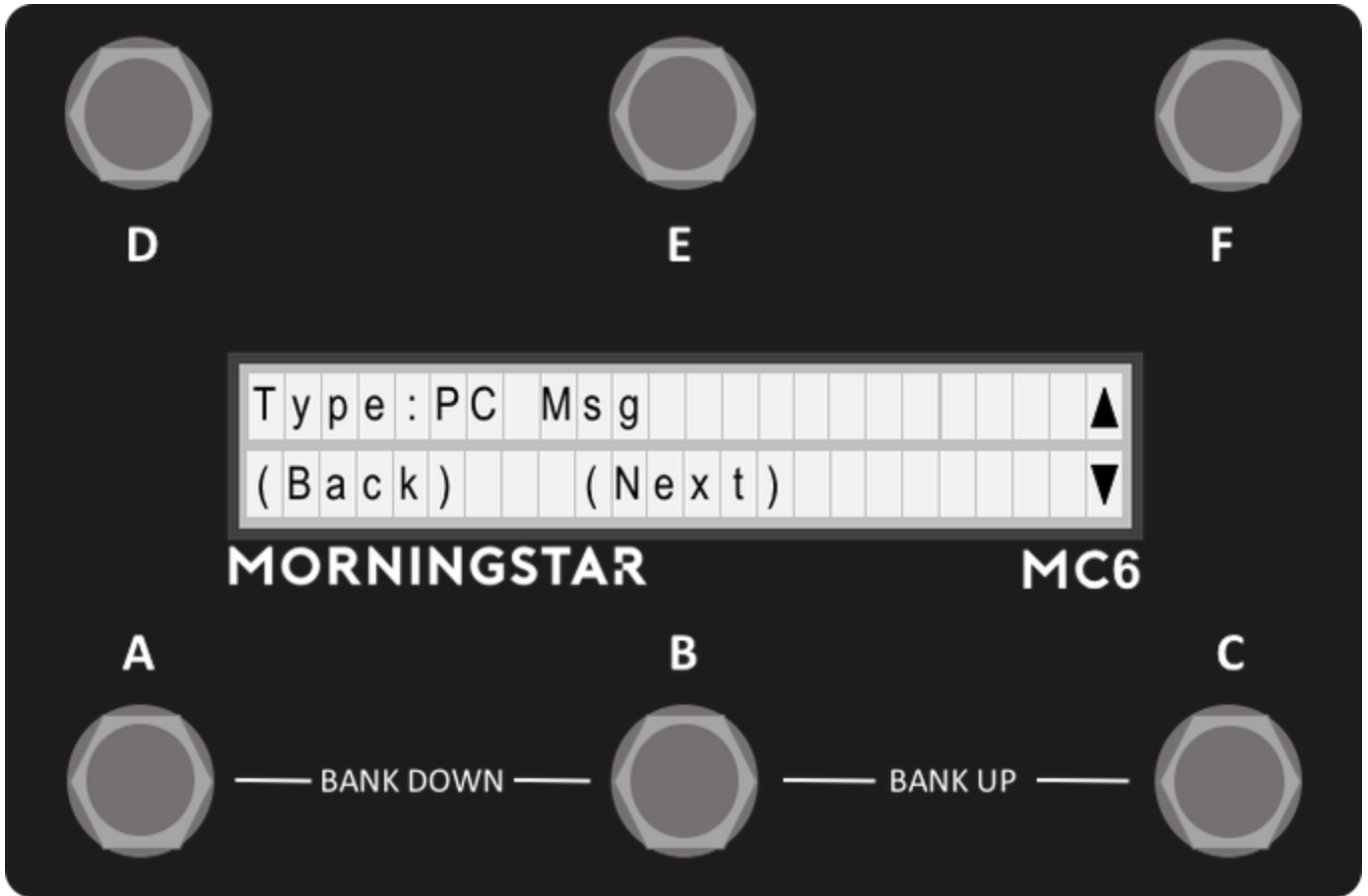

Depending on the MIDI Type that is selected in the previous menu, unique parameter edit menus will be loaded. Edit your parameters and then press Save on the last page to save your settings.

Toggle Mode

How to toggle between two different MIDI messages on your MC6 MKII with the same switch
 :movie_camera: Video tutorial available here: <https://youtu.be/VEr0TB58EgA>

Using the Web/Desktop Editor

Setting up a toggle message is easy. On the editor, there is a toggle option on the top left of the interface. Switch it to On to enable toggling for the preset.

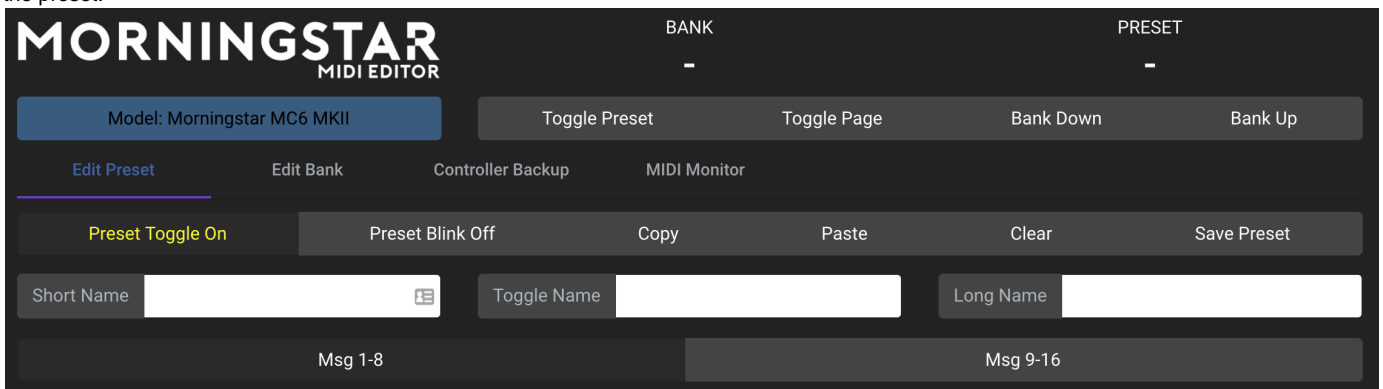

How it works

Each preset on the MC6 allows you to toggle between two positions: 1 and 2. By default, the presets are on toggle position 1. If you switch the toggle position to ON, each time the preset is engaged, it will toggle to the other position (between 1 and 2).

Each message also has a position option, where it will be sent out only when the position of the message matches that of the preset. Hence, if you set `Msg1` to be a `PC` message in `Pos 1`, and `Msg2` to be a `PC` Message in `Pos 2`, and you have your toggle on for the preset, each press will toggle between `Msg 1` and `Msg 2`.

The screenshot displays two rows of configuration for messages. Each row includes a message label (Msg 1 and Msg 2), an Action dropdown set to 'Press', a Type dropdown set to 'Program Change', and a Pos dropdown set to 'Pos: 1' and 'Pos: 2' respectively. Below each message configuration, there are fields for 'PC Number' and 'MIDI Channel'. For Msg 1, PC Number is 0 and MIDI Channel is 1. For Msg 2, PC Number is 1 and MIDI Channel is 1. To the right of each Pos dropdown are buttons for 'Clear', 'Copy', and 'Paste'.

Toggle Name

When the preset is in position 1, the Short Name will be displayed. When the preset is in position 2, the Toggle Name will be displayed.

Blinking

To indicate that the preset is in position 2, you can also use the blink option, where if the blink option is set to On, the Toggle Name on the main page will blink when the preset is in position 2.

Using the built-in MC6 editor

After going into the preset edit menu, go to Page 3 of the menu. The Toggle button toggles between `Toggle On` and `Toggle Off` position for the preset, which the Blink button toggles between `Blink On` and `Blink Off` position for the preset.

When editing individual messages, there will be an option to select the toggle position for the message you are editing. Choose between position 1 or 2 accordingly.

Editing Expression Messages

To edit expression messages, press switch D + F first, which will bring you to the edit page, and then select the expression option.

Expression Edit Menu (Page 1)

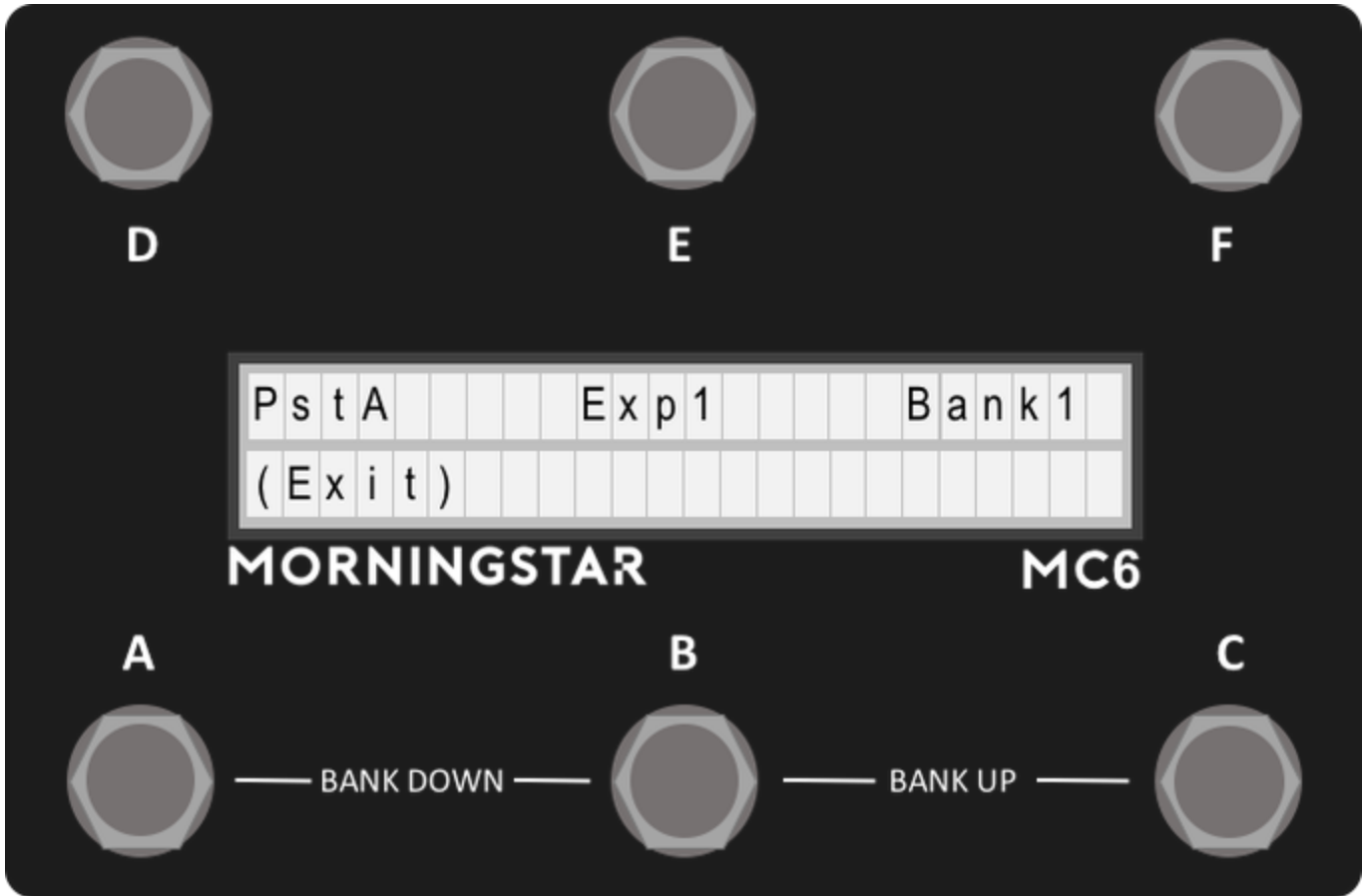

The first page of the menu for editing Expression Messages are the same as that for editing Preset Messages.

Expression Edit Menu (Page 2)

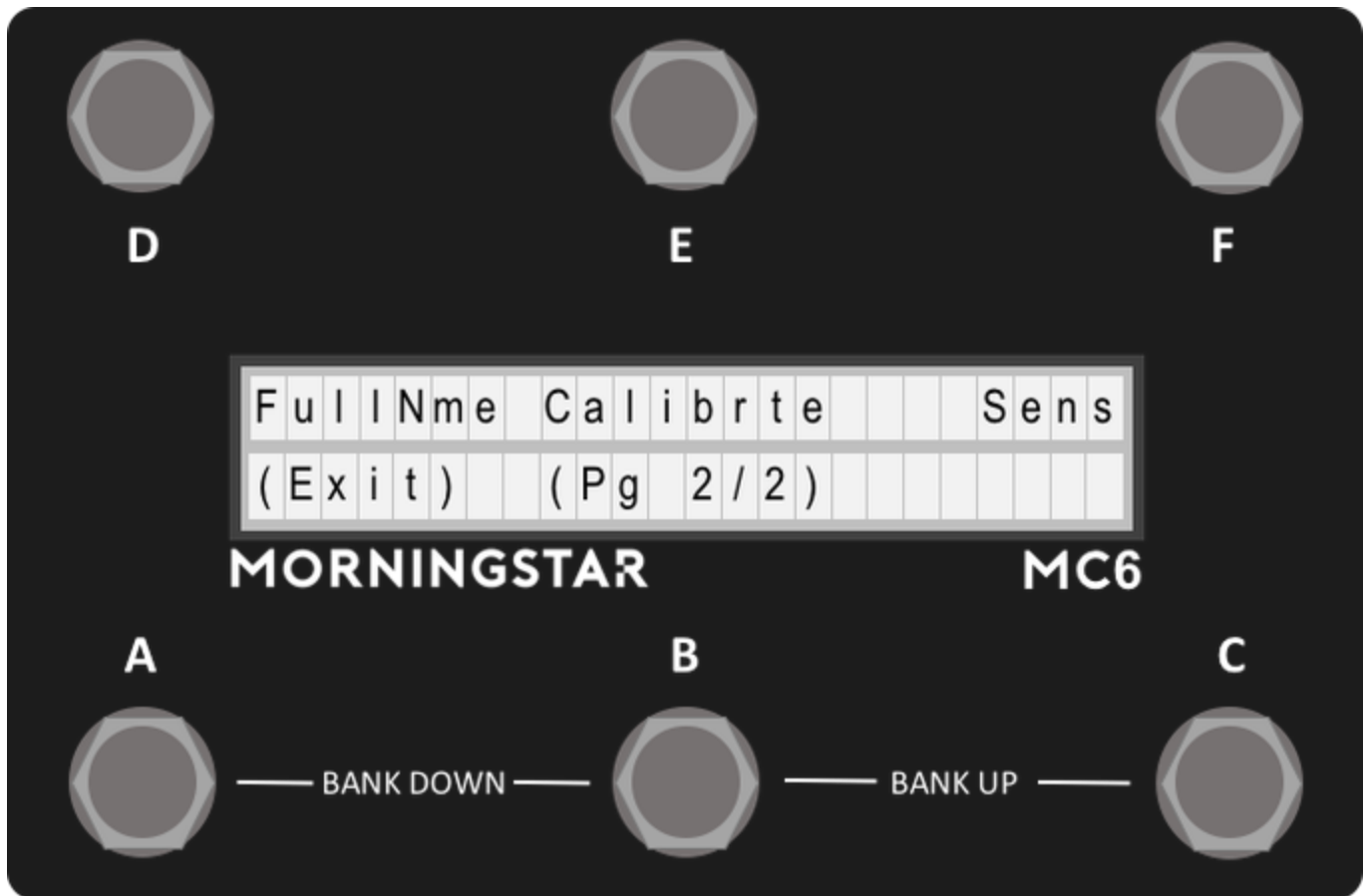

On the second page, you have the option to edit the Full Name, Sensitivity or calibrate your expression pedal.

Edit Full Name

When the expression pedal is being used, you have the option of displaying a Name for your expression preset. Simply edit and save the name to your expression preset. See Editing Names for more information after entering the FullName option in the Expression Edit Menu.

Calibrating your Expression Input

It is best to calibrate your expression pedal before use to get the optimum performance. Simply go into the Calibrate setting in your Expression Edit Menu. Once there, follow the instructions in the LCD. First set your expression pedal to a heel down position. Ideally, the value should be displayed as 0. Press Next. Next, set your expression pedal to a toe down position. Ideally, the value should be displayed as 127. Press Save to save your settings. Do not worry if you can get a value of 0 and 127 in both positions. Once your setting is saved, the MC6 will optimise the settings to get the most out of your expression pedal.

Setting your Expression sensitivity

Depending on the potentiometer value used in your expression pedal, you may have to edit the sensitivity to get optimum performance. We recommend using expression pedals with 10k potentiometers. The sensitivity setting is used mainly to remove jitters, where the value sent by the MC6 might bounce between 2 values very quickly.

Editing Bank Settings

To enter the bank settings, press Switch D + F, which will bring you to the edit page, and then select the Bank option.

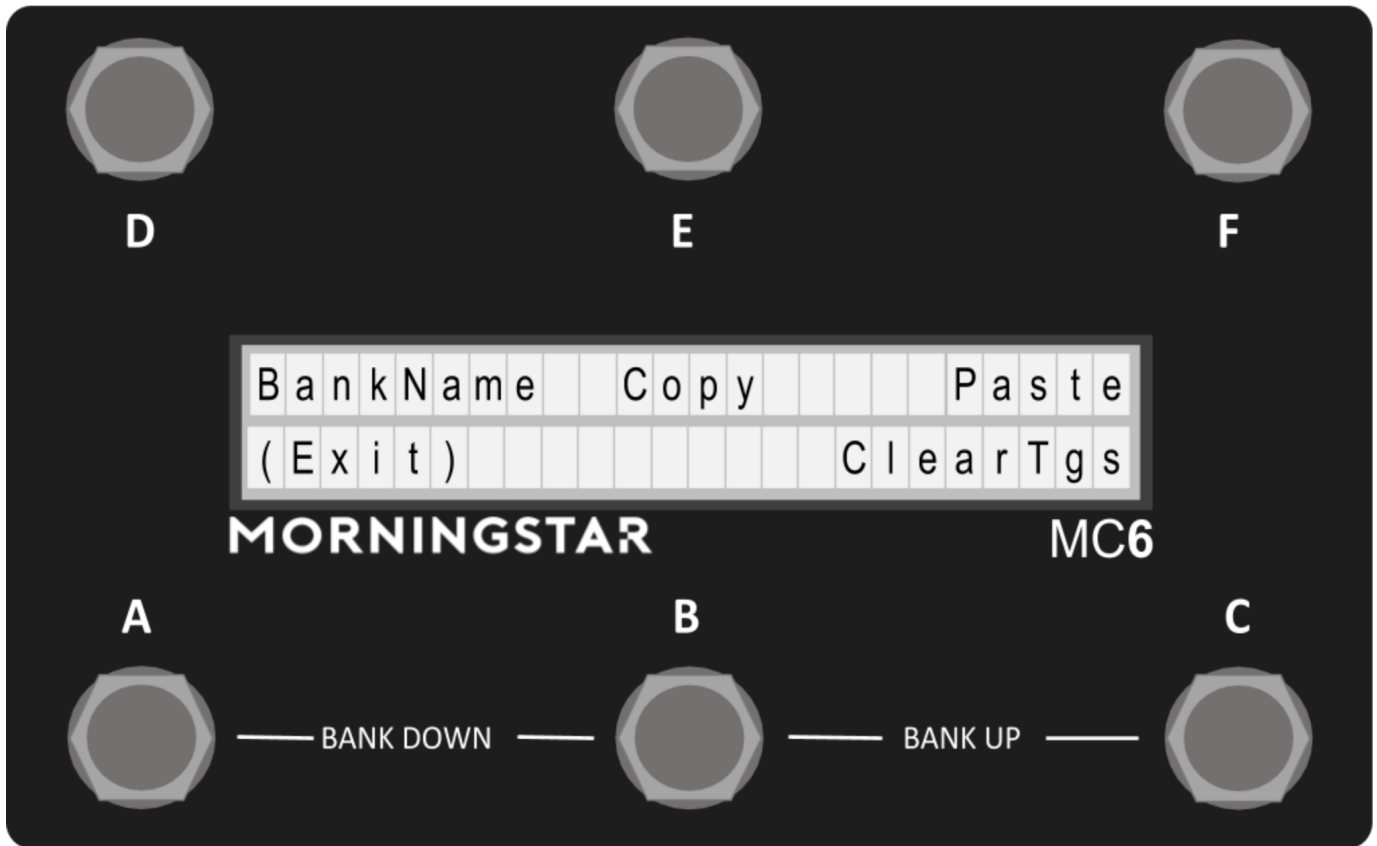

In the edit bank interface, you can edit the Bank Name as well as copy and paste banks.

Bank Name - Edits the Bank Name.

Copy - Copies the current bank.

Paste - Paste the previously copied bank to the current bank.

ClearTgs - Toggles the `Bank Clear Toggle` feature between On and Off. This feature allows you to disengage the rest of the preset toggle positions except for the preset that is just engaged. This is useful when you want the last-engaged preset to blink.

Editing Names

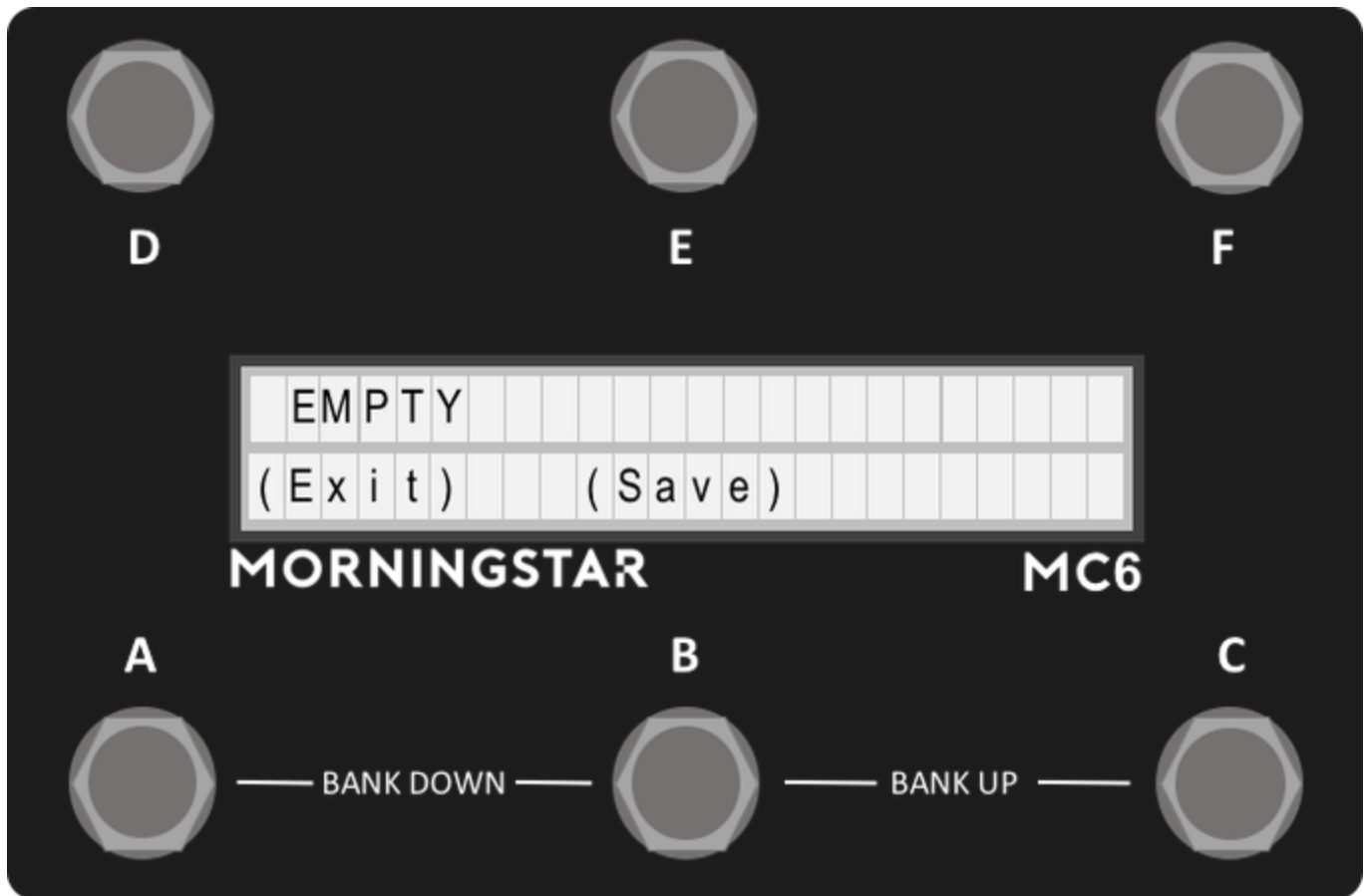

When editing any of the MC6 names like Preset Short Name, Toggle Name, Long Name, or Bank Name, this interface will be display on the screen.

It is possible to display the PC Scroll number in the Preset name by using a placeholder %E0 to %E7. Since there are 8 slots in the PC Scroll function, %E0 will display the number in the first slot, while %E7 will display the number in the 8th slot. %E1 will display the number in the second slot.

Controls - Moving the cursor. To move the cursor left and right, press Switch D or Switch E.

Changing characters - To change the characters, use Switch C and Switch F to scroll up and down the available characters.

(Save) - Saves the name into memory.

(Exit) - Exits the interface.

MIDI Editor

Besides using the on-board MIDI editing features on the MC6 MKII, you can also edit your settings via the Web/Desktop editor. The Web Editor will always contain the latest developments, while the Desktop editor will be updated less frequently. Using the Web/Desktop Editor with your MC6 MKII

The links are available on our website here: <https://www.morningstarfx.com/editor>

NOTE: A number of functions are disabled when the device is in Editor mode. When using or testing the MC6 with other devices, please remember to toggle out of editor mode.

Connecting the device

Connect the device via USB to your computer and launch the editor in the latest version of Google Chrome (the Web Editor works on Google Chrome only).

When the browser prompts you to Allow MIDI devices, click Allow.

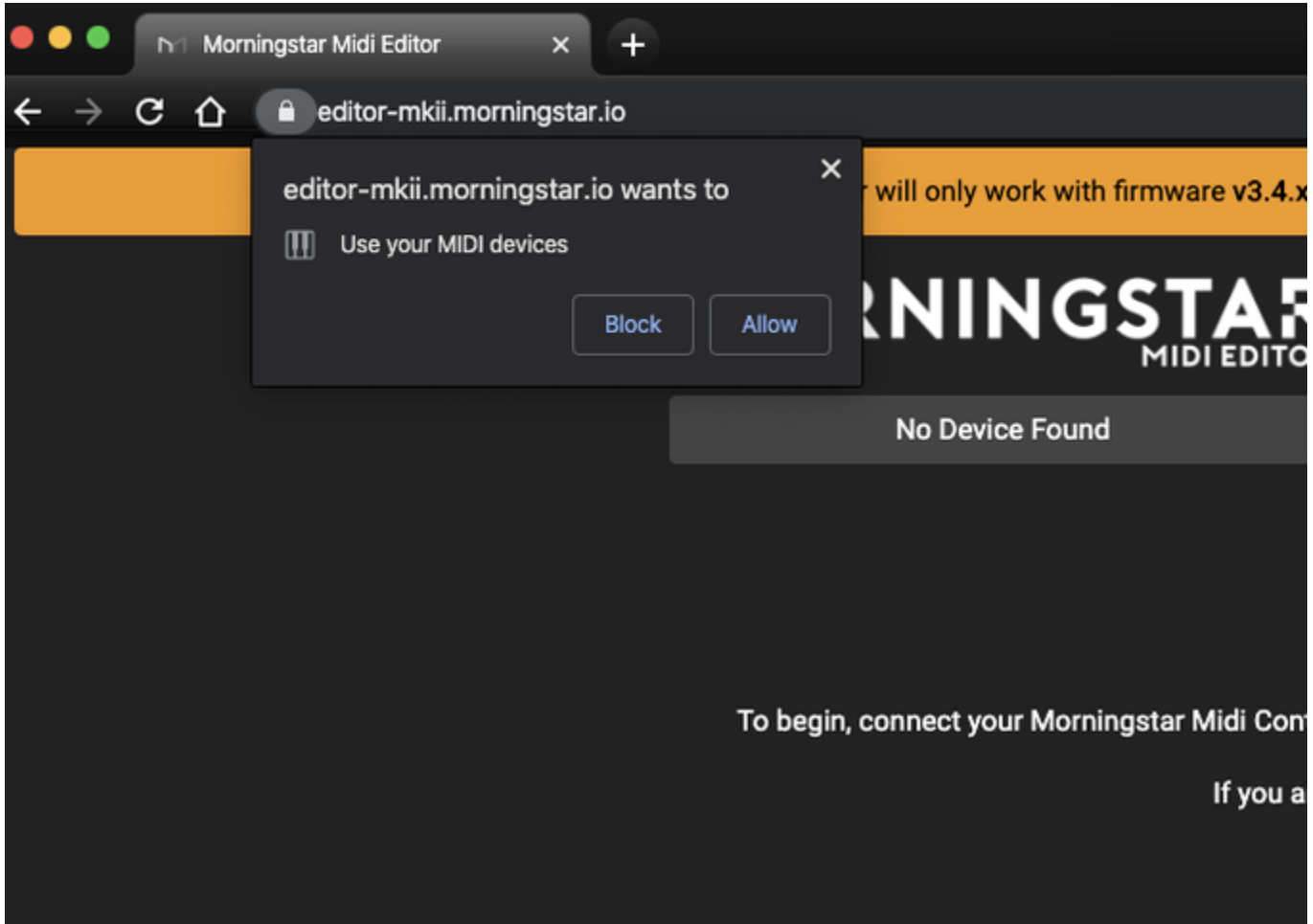

The editor should detect your device and load the editing dashboard as shown below.

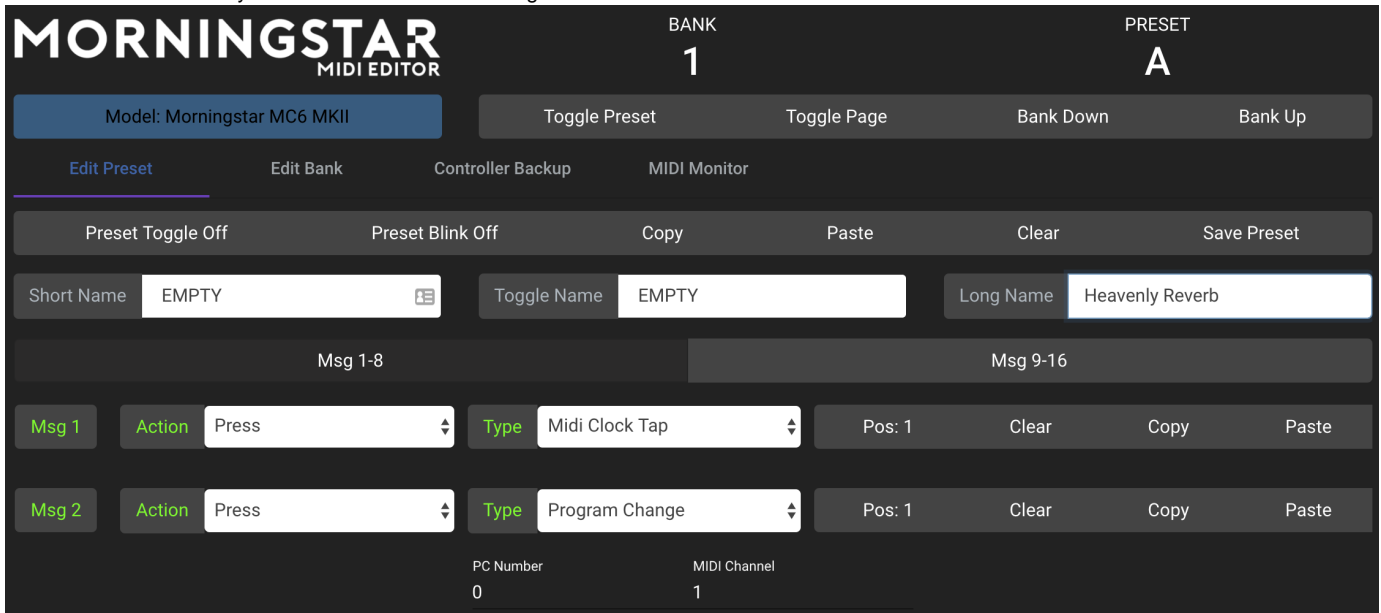

Your device will have to be in Editor Mode for it to communicate with the editor. You can toggle into editor mode by pressing **Switch [C + D]** or by pressing the button below the logo on the editor `Toggle Editor Mode`.

Once your controller is in editor mode, the Model button will turn Blue, indicating that it is communicating with your controller. You can then press any switch on your device to edit the corresponding preset.

To exit Editor Mode, press the blue button again.

To edit your expression pedal, move the pedal and the settings will be loaded on the editor.



The editing parameters are similar to the on-board editing parameters.

Editing Functions

There are various controls on the top right panel of the editor (below the Bank and Preset number display) as well. You can toggle the page on the MC6, Bank up or down or copy and paste presets. You can also clear your preset settings by double clicking the Clear button. This also applies to the Clear button on the individual Messages, where the Clear button has to be *double clicked*.

Device Control Functions

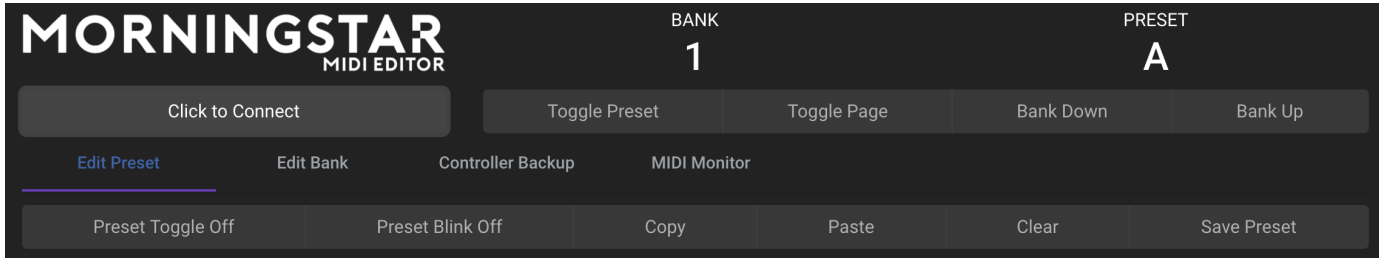

- **Tg Preset:** Toggles the Preset between Position 1 and Position 2
- **Tg Page:** Toggles the device page between 1 and 2 to load Preset A - F or G - L
- **Bank Up / Bank Down:** Bank up and down on the device
- **Copy:** Copy the Preset
- **Paste:** Paste the copied preset to a different selected preset
- **Clear:** Clear the Preset settings. This button has to be double-clicked
- **Save Preset:** Save the settings on the Editor to the device

Preset Editing Options

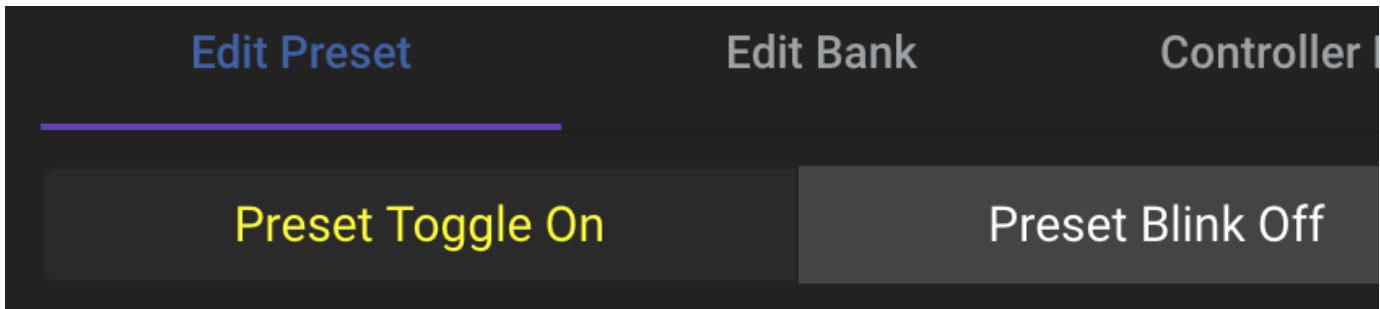

- **Toggle On/Off:** Determines whether the preset should toggle its toggle position each time it is engaged.
- **Blink On/Off:** Determines whether the preset name should blink when the preset is in toggle position 2.

Message Editing Options

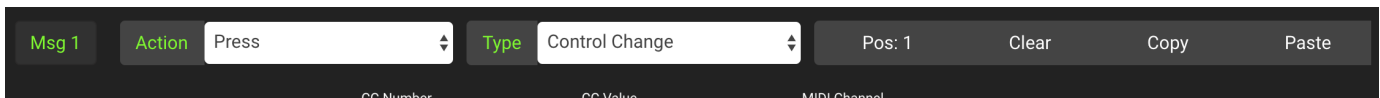

- **Pos button:** Determines if the message should be in Position 1, Position 2 or Both. For example, if Msg 1 is set to Pos 1, it will only engage when the Preset is in Position 1.
- **Clear:** Clears the message. This has to be doubled clicked.
- **Copy:** Copy the message
- **Paste:** Paste the earlier copied message to another message..

Backing Up Your Data

The editor allows you to back up your data into a .syx file which you can later reload into your controller.

On the editor, click on the `Controller Backup` tab. Make sure your device is in `Editor Mode`.

The screenshot shows the Morningstar MIDI Editor interface. At the top, it displays 'MORNINGSTAR MIDI EDITOR', 'BANK 30', and 'PRESET D'. Below this is a navigation bar with buttons for 'Model: Morningstar MC6 MKII', 'Toggle Preset', 'Toggle Page', 'Bank Down', and 'Bank Up'. A secondary navigation bar includes 'Edit Preset', 'Edit Bank', 'Controller Backup' (which is highlighted with a blue underline), and 'MIDI Monitor'. The main content area is divided into two sections. The top section is titled 'Download your controller presets' and contains the text 'Back up your entire controller presets and save the data into a .syx file.' and 'Your controller needs to be in Editor Mode first.' Below this text is a button labeled 'Save Controller Data'. The bottom section is titled 'Restore your controller presets' and contains the text 'Select your backup .syx file and upload the presets into your controller'. Below this text is a file input field containing the text 'Morningstar_MC6_MKII_Backup_File.syx' and a 'Browse' button.

Click on `Save Controller Data`. This will start the download of your controller data in the editor.

This screenshot is identical to the one above, showing the 'Download your controller presets' section of the Morningstar MIDI Editor interface. It highlights the 'Save Controller Data' button and the instructions for backing up the controller data.

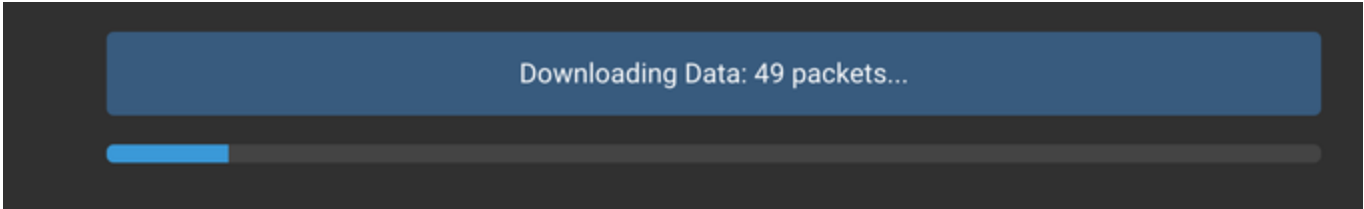

Once the download is complete, a `Save` Dialog box will appear, and you can select the folder to save your file in your computer.

To load the `.syx` file back into your controller, click on `Browse` to locate the file in your computer. If the file is valid, a green button will appear.

Restore your controller presets

Select your backup `.syx` file and upload the presets into your controller

Good to go! Click here to UPLOAD the data to your controller.

Click on the green button to start uploading the data into your controller.

If this process hangs halfway, please refresh the page and try again.

Naming your MIDI Channels

From firmware v3.6 onwards, you can name each MIDI channel. This feature is available in the `Controller Settings` tab, under `Edit MIDI Channel Names`.

Edit MIDI Channel Names

Channel 1 Bigsky	Channel 2 Timeline	Channel 3 H9	Channel 4 Enzo
Channel 5 MIDI Channel Name	Channel 6 MIDI Channel Name	Channel 7 MIDI Channel Name	Channel 8 MIDI Channel Name
Channel 9 MIDI Channel Name	Channel 10 MIDI Channel Name	Channel 11 MIDI Channel Name	Channel 12 MIDI Channel Name
Channel 13 MIDI Channel Name	Channel 14 MIDI Channel Name	Channel 15 MIDI Channel Name	Channel 16 MIDI Channel Name

After naming the channels, press `Save` and the settings will be saved to your device. Now, when you edit your Presets, the names will appear in the MIDI Channel dropdown box.

Msg 1-8 | 1-16

Msg 1 | Action | Press | Type | Control Change | Copy | Paste

1 -> Bigsky
2 -> Timeline

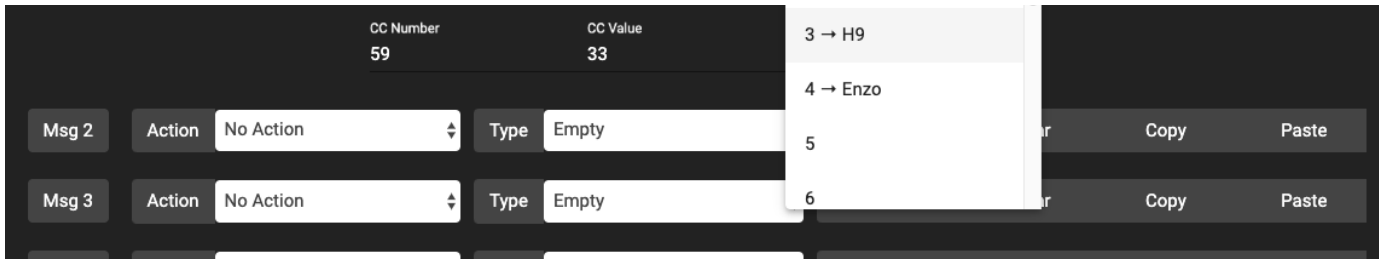

Firmware Update

We are constantly updating the firmware to include new features and bug fixes.

:movie_camera: Video tutorial - How to update your firmware: <https://youtu.be/wtvX8Y9LzXo>

What to download

You'll need to use the Firmware Uploader software to upload the firmware to your device.

Download the latest Firmware Uploader software here.

Download the latest firmware here

Upload instructions

Open the Firmware Uploader

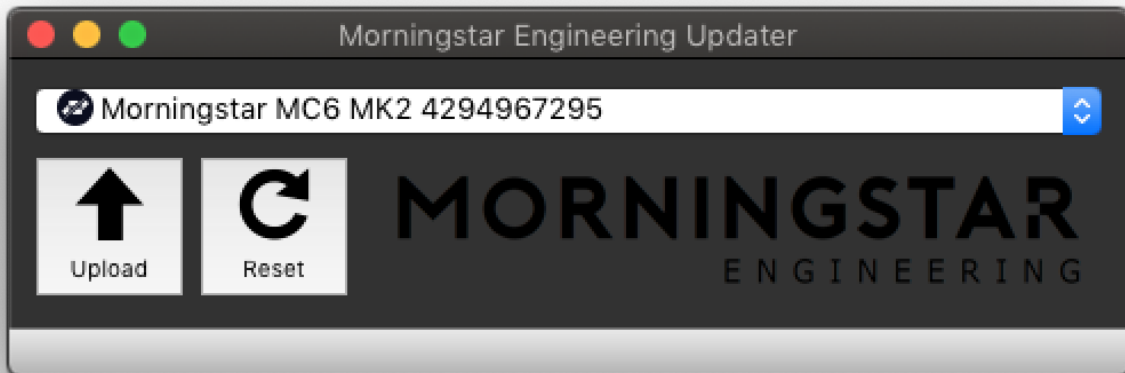

If your device is connected, it will appear in the Firmware Uploader software.

Click on Upload and select the firmware .hex file.

The firmware should then begin uploading and should take only a couple of seconds. Once it is completed, your device will restart with the new firmware.

Troubleshooting

In the rare event where your device upload is not successful, the device might appear to be bricked with blocks showing across the LCD screen. Do not worry and follow these steps:

1. Download the latest firmware from our website.
2. Remove the back cover for your device and locate the reset button. It is located on the underside of the circuit board, towards the lower left when facing the MC6 from the top.
3. While the device is connected to your computer via USB, and with the Firmware Uploader open, press the reset button location on the PCB.
4. Once pressed, the Firmware Uploader should detect the device. Thereafter, repeat the above upload procedure.

MIDI Implementation

MIDI implementation chart for the MC6 MKII.

The MC6 MKII can respond to **CC** and **PC** messages from the USB MIDI port and MIDI IN port to execute specific functions. You can send **PC** or **CC** messages via an external MIDI controller or software to control the MC6 MKII functions specified below.

PC Messages

PC messages will change the banks on the MC6 MKII, where a **PC#0** message will engage Bank 1, and **PC#1** message will engage Bank 2, and so on.

CC Messages

Function	CC#	Value
Bank Up	0	any
Bank Down	1	any
Set Toggle (All)	2	127
Set Toggle (Individual)	2	0 - 11 (0 = Preset A)
Clear Toggle (All)	3	127
Clear Toggle (Individual)	3	0 - 11 (0 = Preset A)
Page Toggle	4	any
Engage Preset	10 - 21 (10 = Preset A)	0 = Do Nothing 1 = On Press 2 = On Release 3 = On Long Press 4 = On Long Press Release 5 = On Double Tap 6 = On Double Tap Release 7 = On Double Tap Hold 8 = On Double Tap Hold Release